

Engine Complete KIT : Spec.SUPER HEAD 4VALVE + R

(4SM-148)

Primary kick starter

SUPER HEAD 4VALVE + R -148

4-Speed

Item No. : 0 1 0 0 9 2 0 2

Compatible models

Monkey / Gorilla : Z50J -2000001 ~

: AB27-1000001 ~ 1899999

Thank you for purchasing our Complete Engine.

This engine is one of our Engine Complete Series which we have designed and produced by using with years of our experienced product development and manufacturing know-how.

We are proud of that we guarantee customer satisfaction with such a lightweight and high power engine.

Before installing and using this product, please check the contents of the kit, read this installation instructions carefully and understand them completely.

Important Notice

- 1 . Please Note: Illustrations and photos may vary from actual hardware.
- 2 . The service and repair information contained in this manual is intended for use by qualified, professional technicians. Any person who does not have sufficient technique, knowledge, proper tools and equipment will never work. Be sure to ask specialty shops or professional mechanics.
Poor technique and lack of knowledge may cause the maintenance problems or damage parts.
- 3 . This product is intended for use ONLY in closed racing course. Never use this product on public roads.
- 4 . This kit is compatible with the above mentioned compatible models ONLY. Note: Do Not use this product for other models than listed above.
- 5 . The cylinder length of this complete engine is longer than that of the stock engine.
It is impossible to install on stock motorcycle chassis. NOTE: Modification of the chassis is required.
- 6 . Please note that mainly because of improvement in performance, design change, and cost increase, the product specifications and prices are subject to change without prior notice. We shall be held free and harmless from any and all liabilities or claims for any defects of the parts / the product after installation, and use, and/or any other products/parts.
- 7 . We do NOT accept any claims due to the parts for racing use only. Except, any requests for the return or repair of goods purchased from TAKEGAWA must be made within one month of receipt of goods against defects in workmanship and/or materials originally caused by ONLY our failure. No returns or repairs will be accepted after one month. However, we DO NOT accept our products which are NOT installed in the right way and/or DO NOT used properly.
We are not responsible for any expenses for repair or replacements.
NOTE: When you use for racing, we shall be held free and harmless from any and all claims.
- 8 . These instructions should be retained along with this product.

Read all instructions first before starting the installation.

We do not take any responsibility for any accident or damage whatsoever arising from the use of this product not in conformity with the instructions in this Manual.

While working on this product, be sure to proceed with the proper work in accordance with the instructions.

Be sure to prepare the genuine service manual of the compatible models and work as instructed. The service and repair information contained in this installation instructions and the genuine service manual are intended for use by qualified, professional technicians.

Be sure that any person who attempts service or repairs without the proper experiences, tools and equipment ask specialty shops or professional mechanics.

We shall be held free and harmless from any and all liabilities or claims for any defects of the parts/the product after installation, and use, and/or any other products/parts.

Do not use other manufacture's ignition parts, or it will cause the failure.

The necessary parts for this kit should be all TAKEGAWA-recommended parts. Always use our recommended parts.

Use TAKEGAWA-recommended fuel and engine oil.

Do not keep engine running in idle position for long period of time. It exceeds engine temperature, which cause the damage of the engine.

 **CAUTION** The following show the envisioned possibility of injuries to human bodies and property damage as a result of disregarding the following cautions.

- This Kit is designed for closed course competition purposes only. So please do not drive on a public road after the installation of this Kit.
- Before starting the installation, make sure the engine and muffler are cool at below 35 degrees Celsius. (Otherwise, you will burn you.)
- Prepare right tools for the work. (Otherwise, the installation with improper tools could cause breakage of parts or injuries to you.)
- As some products and frames have sharp edges or protruding portions, please work with your hands protected. (Otherwise, you will suffer injuries.)
- Always use new gaskets, seals and the like. The continued use of the worn or damaged ones will cause engine trouble.

 **WARNING** The following show the envisioned possibility of human death or serious injuries to human bodies as a result of disregarding the following warnings.

- Those who are technically unskilled or inexperienced are required not to do the work. (Improper installation because of insufficient skill or knowledge could lead to parts breakage and subsequently to accidents.)
- Before doing work, place the motorcycle on level ground to secure your motorcycle for safety's sake. (Otherwise, your motorcycle could overturn and injure you while you are working.)
- Always start the engine in a well-ventilated place, and do not turn on the engine in an airtight place. (Otherwise, you will suffer from carbon monoxide poisoning.)
- As gasoline is highly flammable, never place it close to fire. Make sure that nothing flammable is near the gasoline. (Otherwise it may cause a fire.)
- Tighten to a specified torque using a torque wrench. (Otherwise, improper tightening may cause the bolts or nuts to get damaged or come off, leading to accidents.)
- Never use the parts unspecified by us. (This may lead to parts breakage and consequent accidents)
- If you find damaged parts when checking and performing maintenance of your motorcycle, do not use these parts any longer, and replace them with new ones.
(The continued use of these damaged parts as they are could lead to accidents.)
- When you notice something abnormal with your motorcycle while riding, immediately stop riding and park your motorcycle in a safe place to check what has gone wrong.
(Otherwise, the malfunction could lead to accidents.)
- Carry out inspection and maintenance of your motorcycle correctly according to the instructions and guidelines in the service manuals. (Use TAKEGAWA-recommended fuel and engine oil.)
- Fuel must always be high-octane gasoline. (Otherwise, troubles such as engine knocking may cause accidents.)
- When driving a bike, a driver must always wear a helmet securely. Otherwise, the driver is likely to be subject to death or serious injury in an accident.

Features

Use of Roller Rocker Arm:

We have used roller bearings in the slipper instead of a conventional slipper type rocker arm. The use of the roller bearings helps to reduce friction and makes possible the smooth and constant tight grip on a cam profile at all revolutions from low-speed to high-speed.

Besides, the increased weight through the use of roller bearings is counterbalanced through the use of an aluminum-forged rocker arm.

Consequently, the higher power output and sustainability on high power have been realized.

Use of 4Valve:

Have 2 valves for each Intake and Exhaust, which can have total valve curtain area expand 12% more than previous 2 valve head. At the same centrally located spark plug in the combustion chamber. These make more combustion efficiency.

4 Kinds of Option Cam:

As removal and installation of a cam shaft on the Super Head 4Valve +R is easy, we have prepared 4 kinds of cam shafts. Thus, you can enjoy the customized engine and high driving performance by changing the cam shafts to meet the way of driving such as off-road driving and driving-on-the road.

Removal and Installation of Cam Shaft:

Stock and most of head are needed disassembly to make a change of camshaft, however our Super Head+R 4 Valve head is possible camshaft change without take a part of head. (Even rocker arm stay in the head) So, you can change and try different type of camshaft easy. At the racetrack this feature is profitable.

Use of Plated Cylinder:

This cylinder is aluminum one-piece construction and the ceramic chrome plated inner wall allows the additional wear-resistance and the reduced friction loss. It also features both high gas tightness and durability.

Use of Oil Jet:

We have installed the oil jet which works to jet-spray the oil to the rear side of the piston from crankcase oil line in order to cool the piston.

Use of Wet Multiple-Disk Clutch:

We have installed a multiple-disk clutch with 5 disks onto the transmission main shaft so it can respond to even high output powers.

This arrangement serves to improve durability of the crankshaft and throttle response. In addition, we have installed a highly-reliable cartridge oil filter on the clutch cover. The clutch cover is so structured that a new line is prepared for taking out an oil cooler from the clutch cover and a thermostat can be installed as an option.

Use of close ratio transmission:

The close ratio transmission is designed to enable smooth shift up and down and cornering, and, moreover, effective transmission of engine power.

Use of an automatic decompression camshaft:

We have designed this automatic decompression mechanism so the temporary decompression by this mechanism on the camshaft makes it easy to press down on the kickstarter arm to the end, even if the engine is highly compressed.

Use of Primary Kickstarter System

Primary Kickstarter System is more useful kickstarter system than the conventional C-type engine's. Primary kickstarter (all gear start) system allows the engine to start without shift action. Especially this system is valuable system for competition use.

Use of Lightweight Outer Rotor ACG

SS-outer rotor is equipped as standard .Rotor body is a compact design and it weighs 536g. The best ignition timing is set up exclusively for this complete engine and the quick response has been achieved.

~ Kit contains ~

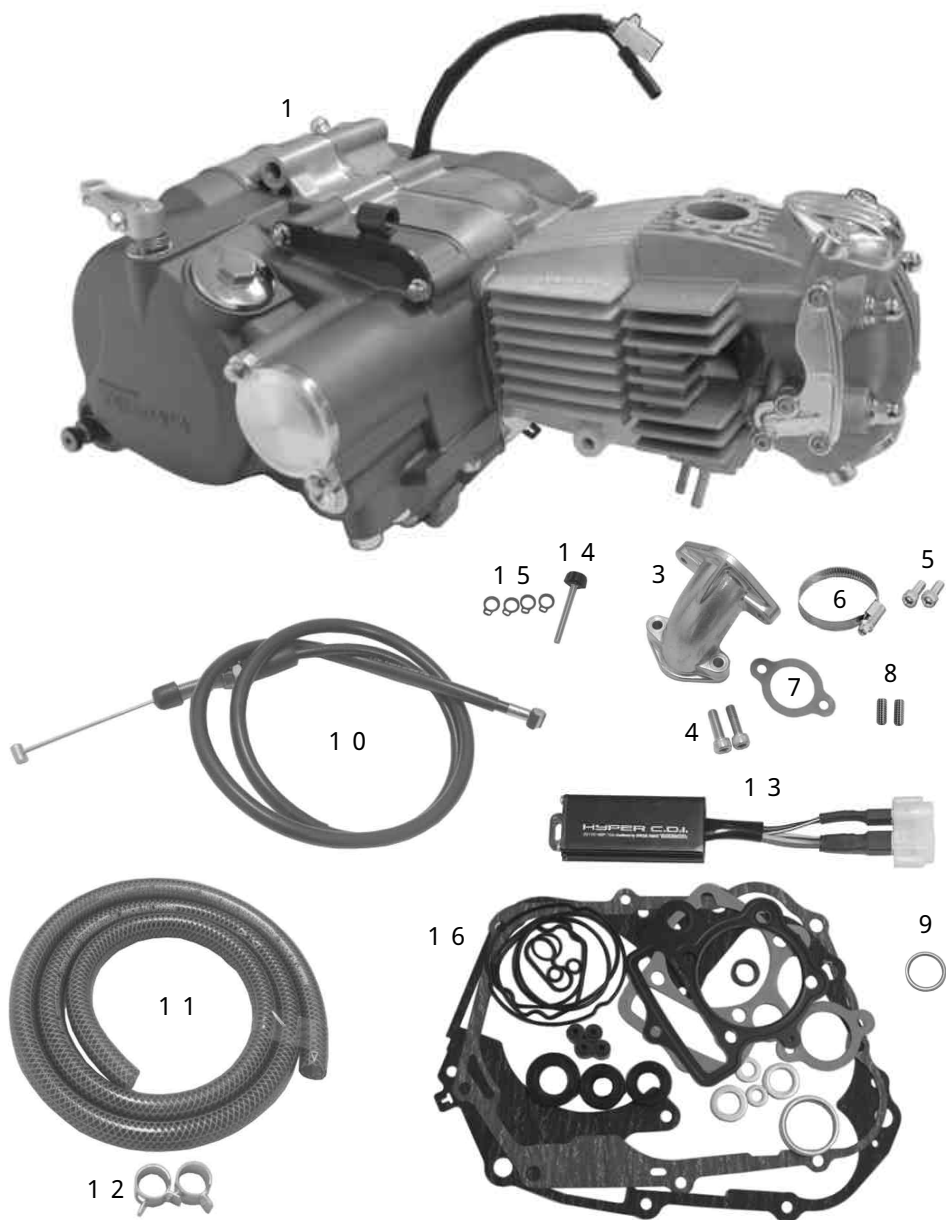

No.	Part Name	Qty	Repair Part Item No.	In packs of
1	Engine COMP.	1		
2	Spark plug, ER8EH	1	NGK-ER8EH	1
3	Intake manifold	1	06171-4SM-T00	1
4	Socket cap screw, 6 x 25	2		2
5	Socket cap screw, 6 x 15	2		2
6	Norma Torro Band	1		1
7	Inlet pipe gasket	1		1
8	Socket set screw, 6 x 15	2		2
9	Exhaust pipe gasket	1	00-01-0064	2
10	Clutch cable COMP., 910 mm	1	22870-086-T00	1
11	Braided hose, 8 x 1 m	1	00-07-0070	1
12	Hose clamp, 13.1	2		2
13	Hyper CDI	1	05-03-0003	1
14	Thumb screw	1	00-01-0254	2
15	Snap ring, 6mm	4	00-01-0255	5
16	Rebuilt gasket set	1	06111-4SS-T20	1
17	Spark plug cap COMP.	1	30700-4SS-T00	1
18	Plug socket, 13mm	1	00-00-0247	1
19	Alumi special (5 g)	1	00-01-0001	1

Please order repair parts with the Repair Part Item No. Without the repair part item NO., we may not be able to accept your orders.

Some parts are only available as a set. In this case, please order them with the set number.

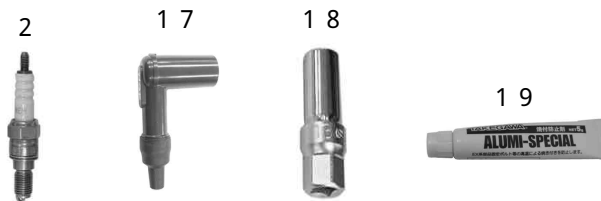

Main Reference Value

Type	4-cycle gasoline
Displacement	147.6cc
Number of cylinder and arrangement	Horizontal single cylinder
Cooling method	Air-cooling
Valve train	Chain drive and SOHC
Chamber design	Pentroof (Hemispherical) type
Bore and Stroke	59mm x 54mm
Compression ratio	13.0:1
Camshaft type	20 / 25D (w/Auto-decompression)
Valve timing:	(1mm lift)
Intake open	15 ° BTDC
closed	45 ° ABDC
Exhaust open	50 ° BBDC
closed	20 ° ATDC
Lubricating method	Combined use of force feed system & splash lubrication system
Pump type	Trochoid type
Capacity	0.85 liter
Fuel to be used	High-octane gasoline (research method: over 97 octane value)
Ignition system	CDI ignition
Spark plug	NGK-ER8EH
Starting method	Primary kickstarter system
Power transmission	
Clutch	Wet multi-disk
Operating mode	Mechanical
Transmission	
Type	Constant mesh, 4-speed return
Gear ratio	
1st speed	3.182 (35 / 11)
2nd speed	1.706 (29 / 17)
3rd speed	1.238 (26 / 21)
4th speed	0.917 (22 / 24)
rear-wheel-drive mechanism	
Type	Chain drive

Inspect and Adjust

Items	Frequency	Refer to page
Clean and Inspect Spark Plug	Every 200km	P-C1
Inspect Valve Clearance	Every 500 ~ 600km	P-C2,C3
Change Engine Oil	Every 1000 ~ 2000km	P-C1
Adjust and Inspect Carburetor	Each time	Depend on Carburetor type
Replace Oil Filter	Every 1500 ~ 2000km	P-C2
Adjust Clutch Cable	Every 250km	P-C2
Inspect Clutch Friction Disc	Every 1000km	See Service Manual
Inspect Piston and Piston Ring	Every 1000km	See Service Manual
Inspect Piston Pin	Every 2000km	See Service Manual
Inspect Crankshaft	Every 1000km	See Service Manual
Inspect Cylinder Head and Cylinder	Every 2500km	See Service Manual
Inspect Crankcase	Every 2000km	See Service Manual

Maintenance period in the table is a guideline. You might need to work more frequently depending on the motorcycle usage or condition.

We recommend more frequently maintenance than the maintenance period.

~ Precautions of Use ~

About the specifications of motorcycle to equip

The cylinder length of this complete engine is longer than that of the stock engine.

It is impossible to install on stock motorcycle chassis. NOTE: Modification of the chassis is required.

For Monkey / Gorilla, modify the chassis if necessary after checking whether the installation is possible referring to the following parts and optional parts of P-D1 ~ D4.

Compatible Specifications Data Chart		
Front Fork	Stock fork (Inapplicable) × Spec Modification	Our 27 or 30 Upright Front Fork (See P-D4)
Tyre	—————▶	Larger wheel (10-inch) is recommended according to the power increase.
Top Bridge / Steering stem	Stock fork (Inapplicable) × Spec Modification	Our Top Bridge & Stem Kit or Front Fork Kit 60mm Offset (See P-D4)
Rear Fork	—————▶	We recommend the modification to match the front fork and tire size. (See P-D4)
Oil cooler	—————▶	We recommend to use it according to the heat increase. (See P-D3)
Drive / Driven sprocket	Stock (Inapplicable) × Spec Modification	Final Gear Ratio 2.188 ~ 2.063 (for 10-inch) (See P-D2)
Oil catch tank	Need to Install	Equipped as necessary (See P-D4)

About fuel:

Whenever regular gasoline is remaining in the fuel tank, always replace it with high-octane gasoline.

About oil cooler:

The installation of this product increases the heat release value of the engine, set off by the increase in power. We recommend you, therefore, to install an oil cooler kit, for a long-time high-load running, which keeps oil at appropriate temperatures and prevents such troubles as oil film shortage at high temperatures.

In case you use the breather cap, be sure to use an oil catch tank at the same time.

Due to large displacement engine, blow- by gas volume may increase. Larger capacity catch can are highly recommended. (approx 500 cc)

About upper limit of revolution:

The upper limit of revolutions varies depending on the installed camshaft and other factors. Please install a revolution counter to make sure that you drive the engine at revolutions below the upper limit, referring to the Camshaft Comparison Data List.

Take note that engine racing and sudden acceleration, particularly in the 1st or 2nd gear, tend to exceed the upper limit of revolutions.

Over revolutions will result in nonsmooth revolutions of the engine, not only adversely affecting the engine life, but also possibly breaking the engine in the worst case.

An Engine NO. (Serial No.) is stamped on this engine as identification.

Please specify your Engine NO. when ordering repair part or contacting us.



Engine No. stamped here.
4SMP-10***

IMPORTANT NOTICE :

On removing and re-installing the camshaft

Be sure to use the supplied new snap ring to reinstall the plate. Do Not use the old snap ring. When performing the maintenance, be sure to refer to the Owner's Manual and proceed the tasks.

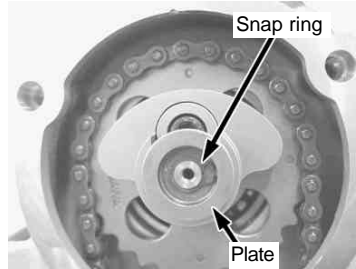

About optional cam shaft:

The following camshafts compatible with this kit are available from us. Referring to the list below, please select a camshaft to match the use, for your great riding pleasure.

You can choose one as an optional part if it matches your bike after confirming the specifications.

10/15D camshaft	01-08-0141
15/20D camshaft	01-08-0142
20/25D camshaft	01-08-0143
25/30D camshaft	01-08-0144

About the descriptions of camshafts and numbers

The bigger the numbers of XX/YY are, the wider the durations are. With these camshafts, the output power will produce more to high rpm range.

While the smaller the numbers are, the narrower the durations are. With these camshafts, the output power will produce more to low-to-mid rpm range. The output features are different from each size.

When purchasing our optional camshafts, please choose the camshaft to suit your riding purpose referring to the camshaft data chart.

Also, the engine output will vary significantly depending on the used exhaust system, length of inlet pipe, carburetor diameter, compression ratio, ignition timing, fuel or the natural phenomenon such as ambient temperatures or atmospheric pressure.

Cam Shaft Comparison Data List

Note: As these are the data measured on a Dyno Jet, the data differ from the actual driving. Please refer to them just for a reference. The engine power varies significantly depending on the temperatures.

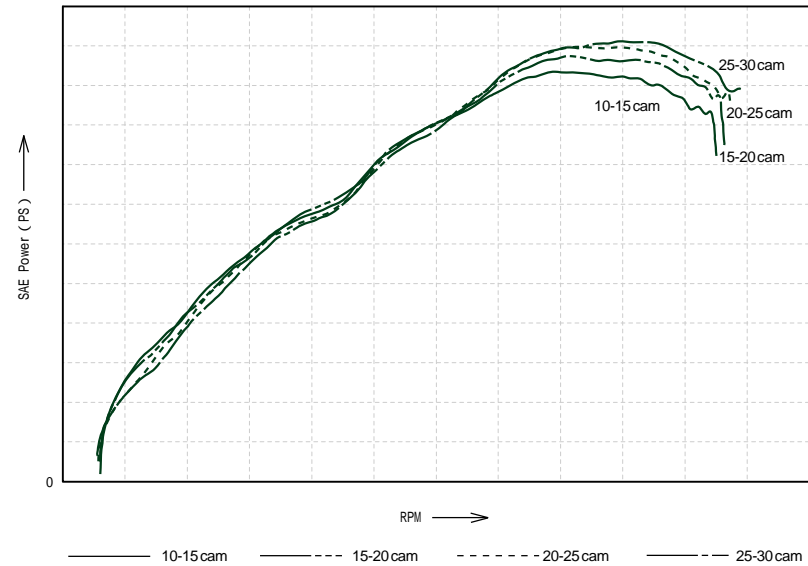

SPECIAL PARTS TAKEGAWA Co.,Ltd.

3-5-16 Nishikiorihigashi Tondabayashi Osaka Japan TEL: 81-721-25-1357 FAX: 81-721-24-5059 URL: <http://www.takegawa.co.jp>

~ Installation Instructions ~

Please Note: Illustrations and photos may vary from actual hardware.

Before starting the installation, please prepare the relative service manual and necessary tools for the motorcycle.

And prepare necessary optional parts as well. For details, please see the attached sheets.

NOTE: This installation instructions are for the models which this complete engine can be equipped.

Remove the engine

Remove the engine and carburetor from the motorcycle referring to the service manual of your vehicle.

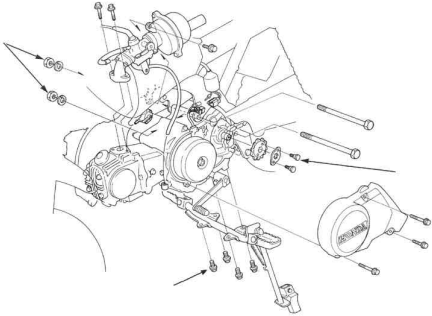

Installation of engine

Install the engine COMP. to the frame referring to the relative service manual for the motorcycle.

- ⚠ Caution : Be sure to follow the specified torque.
- ⚠ Warning : Do follow the instructions in the service manual.

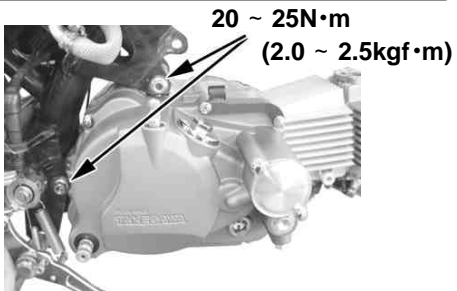

- ⚠ Caution : Be sure to follow the specified torque.
- Torque: 20 ~ 25N·m (2.0 ~ 2.5kgf·m)**

Connect ACG

Replace the CDI with the supplied CDI referring to the service manual of your vehicle.

Connect the wire from Engine COMP and the coupler from the motorcycle.

If you set up the main wire harness as a racing purpose, connect the wires referring to the attached wiring diagrams.

(See P-B6)

For those who ordered without ACG

- Remove the generator cover and install the generator and flywheel following the instructions of your ignition parts.

Installation of clutch cable:

Attach a clutch cable to the clutch lever, and route the cable to the clutch cable receiver, being careful not to stretch it too tight.

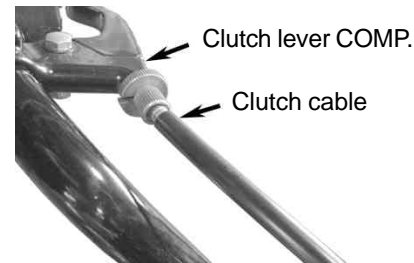

Attach the adjuster of the clutch cable to the cable receiver, and attach the cable end to the arm so the notch on the split clamp of clutch release arm faces backward.

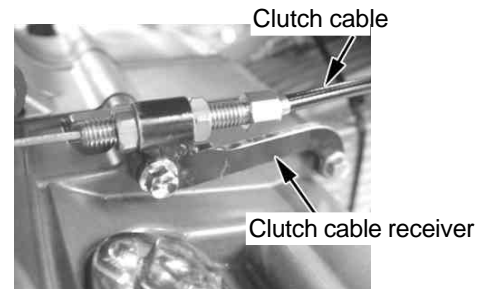

Turn the clutch release pinion clockwise until it comes to a halt, and put the plain washer into the release pinion.

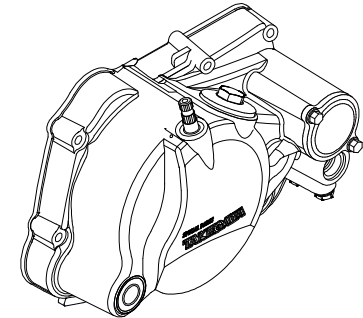
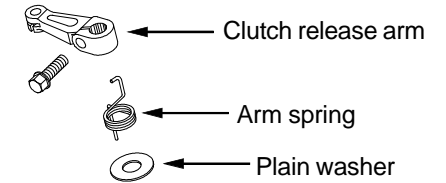

Install the release arm spring on the clutch release arm. Then install the clutch release arm on the release pinion while pulling the cable and install the arm spring on right crankcase cover.

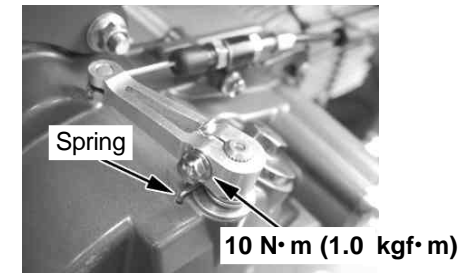

Attach the flange bolt to the release arm, and tighten the bolt to the specified torque, pressing the arm.

⚠ Caution : Be sure to follow the specified torque.

Torque: 10 N·m (1.0 kgf·m)

Adjust the free play at the clutch with the adjuster on the clutch cable, then tighten the locking nuts to the specified torque, and cover the clutch cable adjusters at both ends with rubber caps.

⚠ Caution : Be sure to follow the specified torque.

Torque: 10 N·m (1.0 kgf·m)

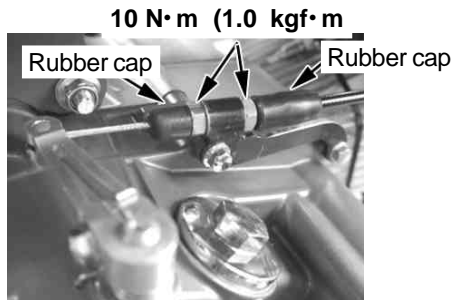

Clutch free play :

10 to 20 mm at the clutch lever end

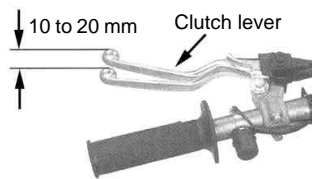

Inspection:

With the engine turned off, shift the transmission to the first gear. Then, check that the rear wheel rotates when you move the machine, squeezing the clutch lever, and that the rear wheel does not rotate when you have released the clutch lever.

Installation of carburetor:

Route the supplied throttle cable along the frame just like the stock throttle cable was routed.

Pass the throttle cable through the lower throttle housing, and connect the inner cable to the throttle pipe.

And attach the throttle housing to the steering handle.

Apply grease to the rubbing surface of the throttle pipe, cable end and the cable taking-up portion on the pipe.

Attach the supplied socket set screw to two taps marked A on the cylinder head surface to attach the inlet pipe to, and tighten the screws to the specified torque.

⚠ Caution : Be sure to follow the specified torque.

Torque: 5 N·m (0.5 kgf·m)

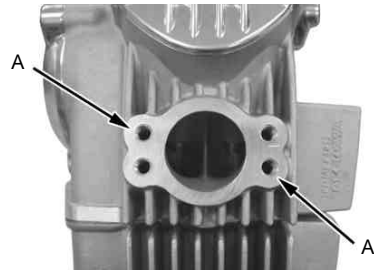

Put an inlet pipe gasket between the cylinder head and the inlet pipe, and tighten it with 6x25 socket cap screw to the specified torque.

⚠ Caution : Be sure to follow the specified torque.

Torque: 10 N·m (1.0 kgf·m)

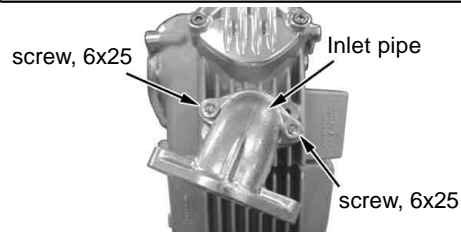

Fasten the carburetor insulator, to be used on the inlet pipe, with the supplied two socket cap screws.

⚠ Caution : Be sure to follow the specified torque.

Torque: 10 N·m (1.0 kgf·m)

In the case of PE28:

Fits only the Monkey

NOT installable onto the Gorilla

Remove a float chamber, and then a main jet. Attach a supplied main jet #110 and slow jet #35, and then a float chamber.

Detach a top cover of the supplied carburetor, and pull out the spring and throttle valve.

Pass the inner cable of the throttle cable through the carburetor top cover and then through the spring.

And compressing the spring, fix the top cover and all to the throttle valve. Fix the throttle valve to the carburetor by aligning a notch on the throttle valve with the throttle stop screw.

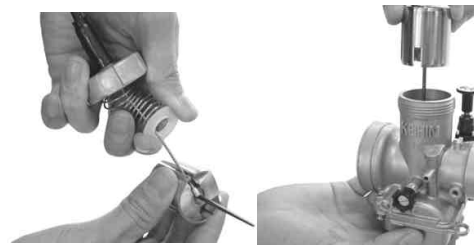

Insert the carburetor into the insulator, and fasten them with a clamp band.

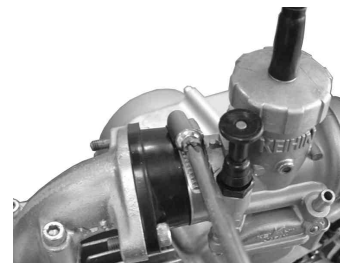

Attach an air filter, which please secure by tightening a band.

Adjust the free play at the throttle grip to be about 5 mm by turning the adjuster of the throttle cable.

Follow the instructions of your throttle cable to adjust the free play.

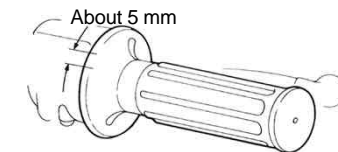
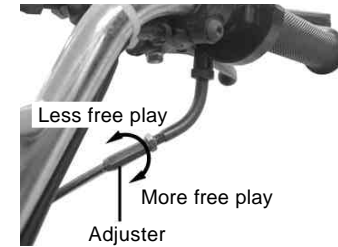

Snap the throttle a few times to make sure that the throttle moves smoothly without sticking and that the throttle valve is fully open. And check that the throttle has free play even when a steering handle is turned all the way to the right or to the left. Insert a fuel tube and fasten it with a tube clip. Open the fuel cock and check for oil leaks.

In the case of VM26:

Remove the top cover from the carburetor, and pull out the spring and the throttle valve. Pass the inner cable of the throttle cable through the carburetor top cover and then through the spring. And compressing the spring, fix the top cover and all to the throttle valve. Fix the throttle valve to the carburetor by aligning a notch on the throttle valve with the throttle stop screw.

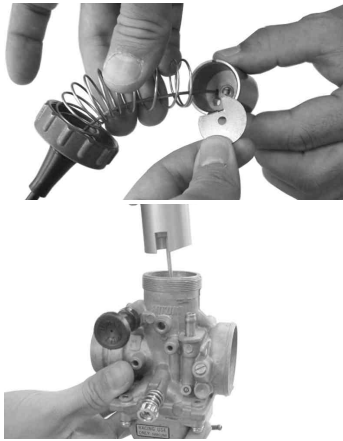

Insert the carburetor into the insulator, and fasten them with a clamp band.



Attach an air filter, which please secure by tightening a band.

Adjust the free play at the throttle grip to be about 5 mm by turning the adjuster of the throttle cable. Follow the instructions of your throttle cable to adjust the free play.

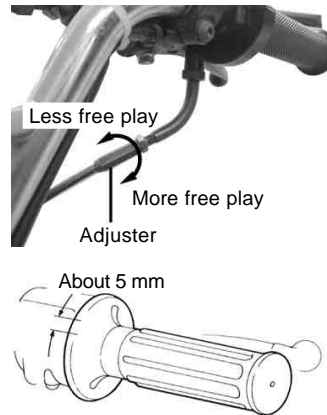

Snap the throttle a few times to make sure that the throttle moves smoothly without sticking and that the throttle valve is fully open. And check that the throttle has free play even when a steering handle is turned all the way to the right or to the left.

In the case of installation to any model of the Gorilla, replace the pre-installed fuel cock with the supplied cock. Adjust the direction of the fuel cock and fasten the nut to the fuel tank.

⚠ Caution : Be sure to follow the specified torque.
Torque: 5 ~ 6N·m (0.5 ~ 0.6 kgf·m)



Insert a fuel tube and fasten it with a tube clip. Open the fuel cock and check for oil leaks. (Do not leave the cock open for many hours.)

Dispose of the blow-by gas from the crankcase by yourself.

(Some races and regulations stipulate the blow-by gas disposal.)

In sending back the blow-by gas to the carburetor, connect the blow-by hose with the union on the air-filter.

(See Optional parts chart on P-D1)

Engine oil

Remove the cap and add 850cc of engine oil.

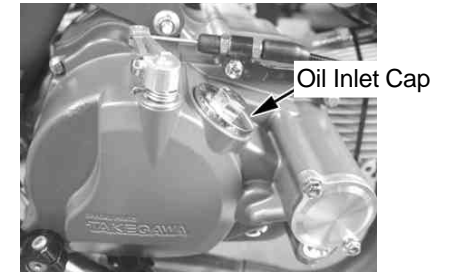

Referring to the chart below, choose the engine oil whose viscosity matches the region and outside temperature.

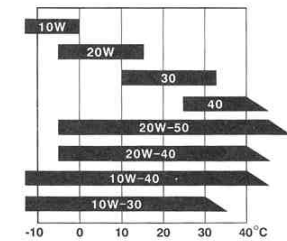

Install the oil inlet cap.

Install an optional kick starter arm.

⚠ Caution : Be sure to follow the specified torque.



Installation of drive chain

Remove the sprocket cover on generator cover.



Install the drive sprocket and drive chain.

⚠ Caution : Be sure to follow the specified torque.
Torque: 12 ~ 15N·m (1.2 ~ 1.5 kgf·m)

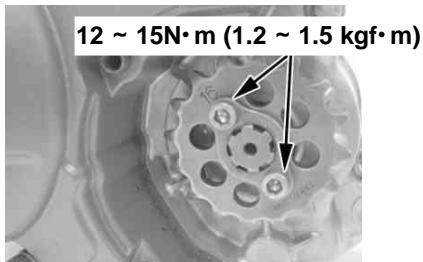

Install the two dwell pins and sprocket cover.
Then tighten the screws to specified torque.

⚠ Caution : Be sure to follow the specified torque.
Torque: 10 N·m (1.0 kgf·m)

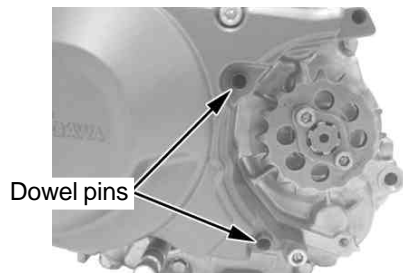

Install the drive chain referring to a genuine service manual or instruction manual for the relative rear fork.

⚠ Warning : Do follow the instructions in the service manual.

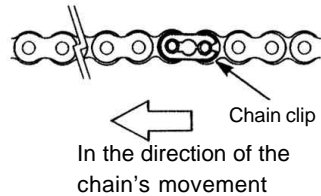

Install the change pedal.

⚠ Caution : Be sure to follow the specified torque.

Install the exhaust system

Attach a supplied exhaust pipe gasket to the exhaust port.



Install an exhaust muffler according to the installation instructions of the relative exhaust muffler.

Start engine

Check that the ignition key and gas cock are turned off.

Keep kicking the starter for a while till the engine oil circulates all around the engine.

Install the spark plug. Lightly apply the "Aluminum Special", the heat-resistant lubricating agent, to the threaded portion on the plug. And tighten the plug.

⚠ Caution : Be sure to follow the specified torque.
Torque: 8 ~ 10N·m (0.8 ~ 1.0 kgf·m)



Attached plug cap.

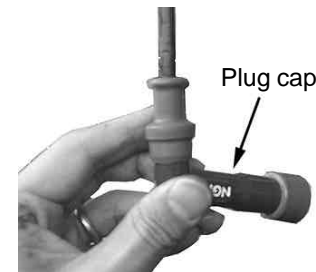

Attach the plug cap to the spark plug.

Thoroughly wipe off dirt and dust on the engine.

Turn on the gasoline cock and the ignition key. Pull a choke lever to start the engine. Gradually loosen your grip on the lever, and warm up the engine till the revolution becomes smooth. And then return the lever fully back to its original location.

If the engine does not run idle after warming-up, or it runs idle at high revolutions, adjust the revolutions with the throttle stop screw.

⚠ Warning : Be sure there is adequate ventilation whenever you run the engine.

Stop the engine once.

Wait for a few minutes and keep the motorcycle level to the ground, and then check the oil amount with oil level gauge on right crankcase.

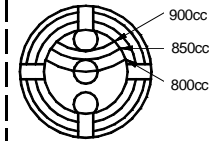

Oil level gauge

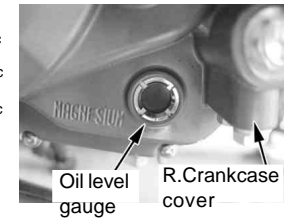

Always keep the oil to the specified level.
(Use the same grade and brand oil.)

Check for malfunctions such as unusual sounds.
If no malfunction is detected, do the setting of the carburetor.
(See the attached sheet)

⚠ Warning : Be sure to do the work in a well-ventilated place.

After the adjustment or setting, carry out a shakedown about 30 to 50 km, and check the valve clearance again.

IN : 0.08 mm

EX: 0.08 mm

⚠ Caution : Be sure to do the work when the engine is cool.

Carry out again a shakedown up to about 50 to 100 km.

After the shakedown, check for malfunctions such as unusual noises or blow-by gas.

(If there is any malfunction, disassemble the engine again to check each part.)

Be sure to proceed the inspection referring to the Owner's Manual. (Purchase the owner's manual if necessary.)

⚠ Caution : Never reuse parts which are not suitable for reuse.

⚠ Warning: Those who are technically unskilled or inexperienced are required not to do the work.

About Optional Clutch Parts:

(Installation of thermo unit)

After removing a thermostat hole cap, install the thermo unit.

For details, see the Instruction Manual for the thermo unit.

The thermo unit alone does not function.

(Oil Cooler Installation)

In case a thermo unit is to be installed:

- 1 . Install a thermo unit.
- 2 . Unfasten two oil plug bolts, and install an adapter suitable for the kind of hose you will use. Then connect the hose.

Please see the instruction manual for the thermo unit.

Please see the instruction manuals for the oil cooler kit and the adapter.

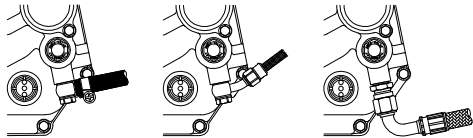

Rubber hose

Slim-line hose

Allegri's hose

⚠ Caution : NEVER install a thermo unit or an oil hole plug if you do not connect an oil hose to the clutch cover. There is a possibility that the engine is damaged due to the oil passage blockage.

In the case of not installing the thermo unit

- 1 . Detach the thermostat hole cap, and fit a supplied oil hole plug into the oil hole.
- 2 . Apply engine oil to the O-rings of the thermostat hole cap, and tighten the hole cap to the specified torque.

Torque: 13 N·m (1.3 kgf·m)

- 3 . Unfasten two oil plug bolts, and fit an adaptor to match the hose to be used. And connect the hose. For details, see the Instruction Manuals for an Oil Cooler Kit and an Adaptor.

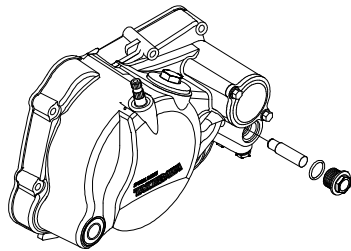

Thermostat hole cap Oil hole plug

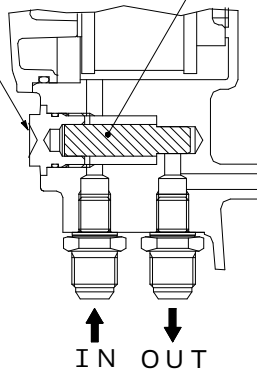

In case an oil cooler is not installed:

NEVER install a thermo unit or an oil hole plug. And in case the thermo unit and / or an oil hole plug is installed, DO be sure to remove it or them.

⚠ Caution : There is a possibility that the engine is damaged because the oil passage will be blocked when the thermo unit or an oil hole plug is installed.

Relevance of Front Fork and Tire

27 Upright Front Fork

For 10-inch tire, clamp the top bridge at the highest point of the front fork.



Before installing, make sure that no interference occurs when the front fork is fully bottomed.

If the interference occurs, use the low profile tire in order not to interfere.

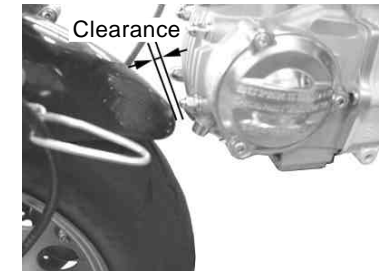

30 Upright Front Fork

Clamp the top bridge at the highest point of the straight portion to avoid the tapered portion of front fork.

Before installing, make sure that no interference occurs when the front fork is fully bottomed.

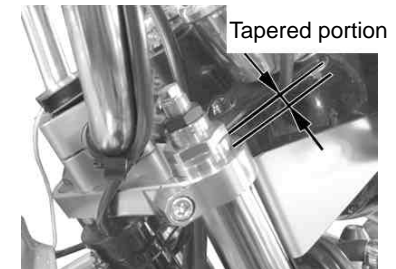

Generator side		Bike side		機能	Function
黄1	Yellow 1	黄	Yellow	灯火用AC出力 (AC電源用)	Lighting AC output (for AC power)
黄2	Yellow 2	白	White	灯火用AC出力 (DC電源用)	Lighting AC output (for DC power)
緑	Green	緑	Green	メインアース (GND)	Main GND
青/黄	Blue/Yellow	青/黄	Blue/Yellow	パルスジェネレーター信号	Pickup pulse
黒/赤	Black/Red	黒/赤	Black/Red	点火用AC出力	Ignition AC output
若葉/赤	Light Green/Red	若葉/赤	Light Green/Red	ニュートラルスイッチコード	Neutral Switch

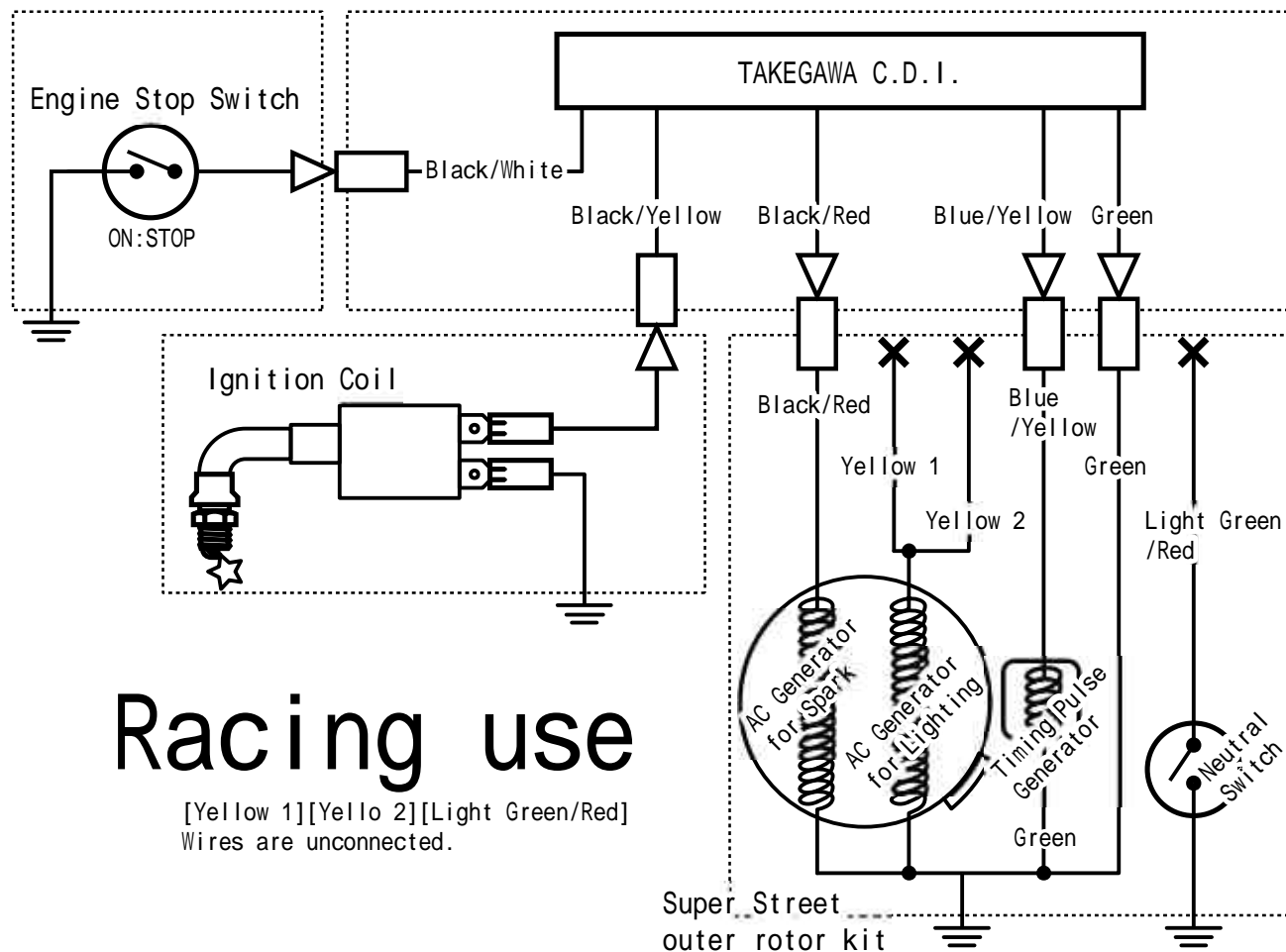

Racing use

[Yellow 1][Yellow 2][Light Green/Red]
Wires are unconnected.

~ Inspections and Adjustments ~

CAUTION Be sure to use a torque wrench and strictly keep the specified torque.

WARNING The inspections and adjustments are intended for use by qualified professional mechanics. Be sure that any person who does not have the proper technique, experiences and knowledge will never work.

Spark plug:

Detach a plug cap, and then a spark plug with a plug wrench.



With a wire brush or a plug cleaner, clear the plug electrode section of the accumulated residues.
Check the plug gap with a thickness gauge.
And when the gap deviates from the benchmark, adjust it by bending the electrode section.

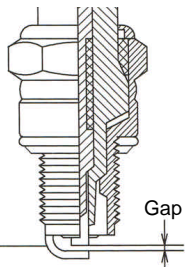

Gap

Benchmark : 0.6 ~ 0.7 mm

Check if the electrode section is worn out, corroded or burnt-out, or its insulator is damaged.
When necessary, change the spark plug.

Check whether the spark plug in use is the one with the right heat value, considering the driving situation and purpose. If the plug seems to be over-burnt, change it with a super plug with a one-step higher heat value.

Standard

- NGK : ER8EH
- DENSO : Y24FER-C

Plug with high thermal value

- NGK : ER9EH
- DENSO : Y27FER-C

Plug with high thermal value

- NGK : ER10EH
- DENSO : Y31FER-C

Apply a small amount of ALUMI SPECIAL on screws of spark plug. Tighten the spark plug and install the plug cap.

Caution : Be sure to follow the specified torque.

Oil Change:

Warm up the engine within a few minutes to normal operating temperature.

Prepare an oil container under the drain bolt.

And drain the oil while the engine is warm.



Install the drain bolt, and tighten it to the specified torque.

Caution : Be sure to follow the specified torque.
Torque: 19.5 ~ 24.5 N · m (2.0 ~ 2.5 kgf · m)

Remove the cap of oil inlet and add 850cc of engine oil.



Add the engine oil in the specified amount.

Recommended oil:

SAE 10W - 40 20W - 50

API class, SF grade engine oil

Oil amount:

When oil change ONLY : 850cc

When rebuilt the engine : 900cc

Referring to the chart below, choose the engine oil whose viscosity matches the region and outside temperature.

Relationship between temperatures and viscosity

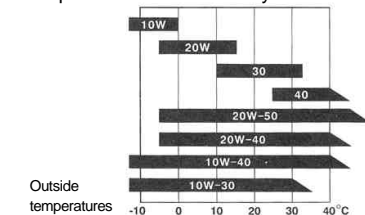

Install the oil inlet cap.

Warm up the engine within a few minutes to normal operating temperature.

Stop the engine once. Wait for a few minutes and keep the motorcycle level to the ground, and then check the oil amount with oil level gauge on right crankcase.

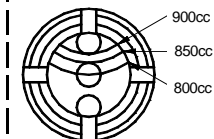

Oil level gauge



Oil level gauge

R.Crankcase cover

Always keep the oil to the specified level.
(Use the same grade and brand oil.)

Change of Oil filters:

Unfasten two bolts on the oil filter cover, and detach the oil filter cover, oil filter and oil filter spring.

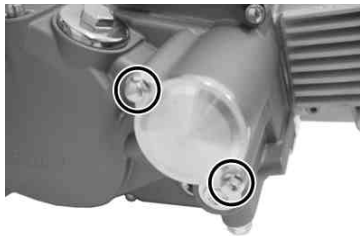

Check the O-ring in an oil filter cover, and change it when necessary.

Attach a new oil filter to the filter cover.

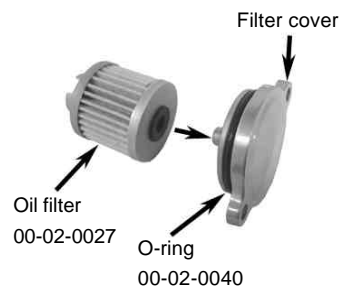

Place the oil filter spring at the protrusion on the right side crankcase cover.

Apply a thin coat of engine oil to the O-ring on the oil filter cover, attach an oil filter and oil filter cover, and tighten two bolts to the specified torque.

⚠ Caution : Be sure to follow the specified torque.

Torque: 10 N · m(1.0 kgf · m)



Adjust the Clutch Cable

Inspect the free play of clutch lever.

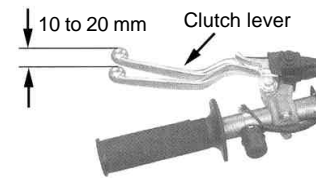

Turn the adjust nut of clutch holder and adjust the free play of clutch lever.

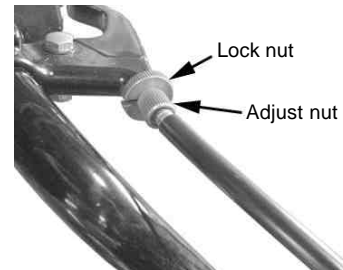

If you cannot adjust the free play with the lever holder, adjust it with the adjust nut of receiver.

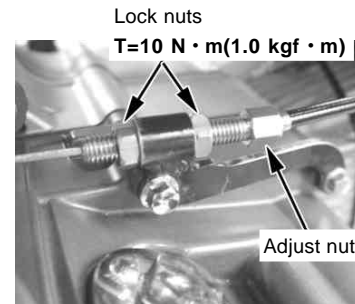

Tighten the lock nuts on clutch lever and clutch cable respectively.

⚠ Caution : Be sure to follow the specified torque.

Adjust the Valve Clearance

Unfasten three screws holding the leftside cover to detach the leftside cover.

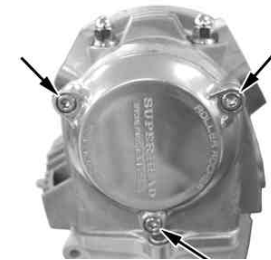

Remove the inspection caps of both IN and EX.

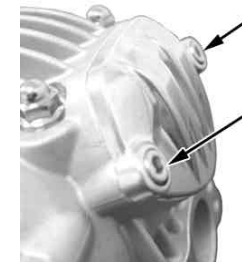

Remove the generator cover (by unfastening the five bolts).



Turn the flywheel and adjust to the top dead center(TDC).

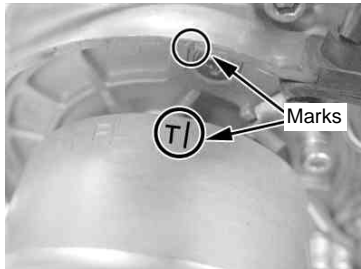
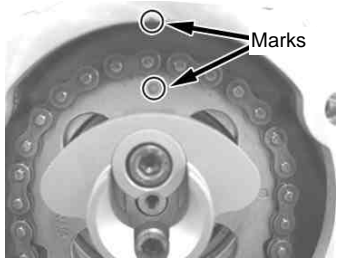

Install a thumb screw in the shaft tap of the camshaft.

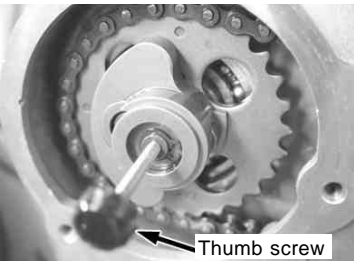

Adjust the valve clearance with an adjust screw.
Valve clearance when your motorcycle is cold:
IN : 0.05 ~ 0.08 (when cold)



Tighten the adjust nut to the specified torque.

⚠ Caution : Be sure to follow the specified torque.
Torque: 10 N · m (1.0 kgf · m)



Adjust the valve clearance on the EX side with the shaft of the camshaft being pulled toward you so that the decompression function can be deactivated.

EX : 0.05 ~ 0.08 (when cold)



Tighten the adjusting nut to the specified torque.

⚠ Caution : Be sure to follow the specified torque.
Torque: 10 N · m (1.0 kgf · m)



Remove the thumb screw.

Re-install the left side cover and the inspection caps of IN / EX.

⚠ Caution : Be sure to follow the specified torque.
Torque: 6N · m (0.6kgf · m)

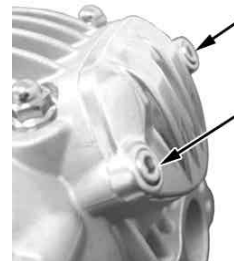
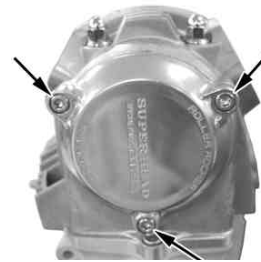

Re-install the generator cover and tighten to the specified torque.

⚠ Caution : Be sure to follow the specified torque.
Torque: 10 N · m (1.0 kgf · m)



How to Set the Carburetor

- When the carburetor does not match the engine and the engine fails, the engine failures are caused by either too dense or too lean air-fuel mixture.
- The engine failure symptoms for the engine are as follows:

When the air-fuel mixture is too dense:	When the air-fuel mixture is too lean:
<ul style="list-style-type: none"> • The explosion sound with a dull thud continues intermittently. • The engine malfunctions further if you use the choke. • The engine malfunctions when you warm it up. • The engine works well if the cleaner is detached. • The motorcycle belches dense (or, black) exhaust gas. • The plug smolders, getting blackened. 	<ul style="list-style-type: none"> • The engine overheats somewhat. • The engine starts working well if you use the choke,. • The engine does not accelerate well. (No smooth acceleration) • Revolutions change, generating weak power. • The plug burns white.

Set the carburetor only after warming up the engine, and then test-drive. And use a plug with the right heat value.
Do the setting in the following manner, studying at what throttle opening position the engine starts failing.

Jet needle (Throttle position at 1/4 - 3/4)

Whether or not the engine revolution is in proportion to the throttle operation

- When the acceleration is not smooth or even, make the air-fuel mixture dense.
- Make the air-fuel mixture lean when the engine revolution goes up heavily and belches black gas.

The mixture ratio at this throttle position can be adjusted by the location of E-ring in the grooves.

The air-fuel mixture becomes dense as the location of the E-ring moves down from the 1st to the 5th groove.

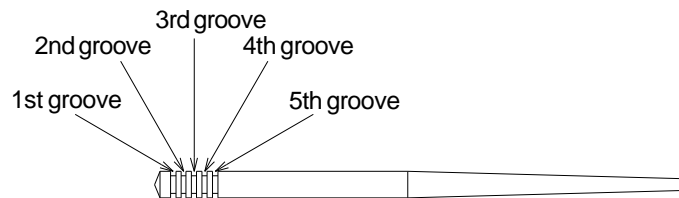

Main jet (The throttle position at 3/4 - 4/4)

The air-fuel mixture ratio at this throttle position can be adjusted by changing the number of the main jet.

The larger the main jet numbers, the denser the mixture ratio becomes.

In view of the engine and muffler specifications, select the most appropriate main jet to get the highest revolutions.

Pilot jet (First of all, please adjust the air screw.)

- In case you have given more than three turns to the air screw to tighten it, use a pilot jet with a small number.
- If you have tighten the air screw (clockwise) to the full, use a pilot jet with a larger number.

Check whether you have made a right choice of the pilot jet by seeing if the engine starts up revolving smoothly from the idling to running at slow speed.

- When the engine revolves up unevenly, the pilot jet number is too small. (At idle)
- When the motorcycle belches black exhaust gas and produces heavy exhaust sound, the pilot jet number is too big. (At idle)
- After replacing the pilot jet, you need to readjust the airscrew.

Air screw

The air screw adjusts the air mass flow at the time of engine's revolving at slow speed. (At idling)

- Give the air screw a right turn The air-fuel mixture gets dense.
- Give the air screw a left turn The air-fuel mixture gets lean.

Loosen the tightened air screw back to the 1.5-turn position. And then from this position, give to the airscrew a right or left turn of 1/4 to 1/2 till the engine revolves at the highest speed.

Loosen the idle stop screw till you get the steady idling revolutions. And once again adjust the position of the airscrew to get the highest revolutions.

On how the barometric pressure, temperatures and humidity affect the setting:

- At highlands or at high altitudes, the barometric pressure and air density go down and the air gets into the carburetor in less amounts.
This makes the air-fuel mixture dense which was adjusted at low altitudes.
- Under the weather conditions with very low temperatures, the air density increases, which makes the air-fuel mixture lean.
- Under the rainy and humid weather conditions, the air density decreases, which makes the air-fuel mixture dense.

Please be informed that, mainly because of improvement in performance, design changes, and cost increase, the product specifications and prices are subject to change without prior notice.

This manual should be retained for future reference.

VM26 Carburetor

Item Nos	Product Names
00-03-0151	Pilot jet, # 10
00-03-0152	Pilot jet, # 12.5
00-03-0153	Pilot jet, # 15
00-03-0154	Pilot jet, # 17.5
00-03-0155	Pilot jet, # 20
00-03-0156	Pilot jet, # 22.5
00-03-0157	Pilot jet, # 25
00-03-0158	Pilot jet, # 27.5
00-03-0159	Pilot jet, # 30



03-03-0321

Item Nos	Product Names
00-03-0060	Main jet, # 100
00-03-0061	Main jet, # 105
00-03-0062	Main jet, # 110
00-03-0063	Main jet, # 115
00-03-0064	Main jet, # 120
00-03-0065	Main jet, # 125
00-03-0066	Main jet, # 130
00-03-0067	Main jet, # 135
00-03-0068	Main jet, # 140
00-03-0069	Main jet, # 145
00-03-0070	Main jet, # 150
00-03-0071	Main jet, # 155
00-03-0072	Main jet, # 160
00-03-0073	Main jet, # 165
00-03-0074	Main jet, # 170
00-03-0075	Main jet, # 175
00-03-0076	Main jet, # 180
00-03-0077	Main jet, # 185
00-03-0078	Main jet, # 190
00-03-0079	Main jet, # 195
00-03-0080	Main jet, # 200
00-03-0081	Main jet, # 210
00-03-0082	Main jet, # 220
00-03-0083	Main jet, # 230
00-03-0084	Main jet, # 240
00-03-0085	Main jet, # 250
00-03-0086	Main jet, # 260

PE28 Carburetor

Item Nos	Product Names
00-03-0137	Slow jet, 35
00-03-0138	Slow jet, 38
00-03-0139	Slow jet, 40
00-03-0140	Slow jet, 42
00-03-0141	Slow jet, 45
00-03-0142	Slow jet, 48
00-03-0143	Slow jet, 50
00-03-0144	Slow jet, 52
00-03-0145	Slow jet, 55
00-03-0146	Slow jet, 58
00-03-0147	Slow jet, 60
00-03-0148	Slow jet, 62
00-03-0149	Slow jet, 65
00-03-0150	Slow jet, 70



03-03-027

Item Nos	Product Names
00-03-0130	Main jet, #82
00-03-0131	Main jet, #85
00-03-0132	Main jet, #88
00-03-0133	Main jet, #90
00-03-0134	Main jet, #92
00-03-0135	Main jet, #95
00-03-0136	Main jet, #98
00-03-0090	Main jet, #100
00-03-0091	Main jet, #102
00-03-0092	Main jet, #105
00-03-0093	Main jet, #108
00-03-0094	Main jet, #110
00-03-0095	Main jet, #112
00-03-0096	Main jet, #115
00-03-0097	Main jet, #118
00-03-0098	Main jet, #120
00-03-0099	Main jet, #122
00-03-0100	Main jet, #125
00-03-0101	Main jet, #128
00-03-0102	Main jet, #130
00-03-0103	Main jet, #132
00-03-0104	Main jet, #135
00-03-0105	Main jet, #138
00-03-0106	Main jet, #140

Item Nos	Product Names
00-03-0107	Main jet, #142
00-03-0108	Main jet, #145
00-03-0109	Main jet, #148
00-03-0110	Main jet, #150
00-03-0111	Main jet, #152
00-03-0112	Main jet, #155
00-03-0113	Main jet, #158
00-03-0114	Main jet, #160
00-03-0115	Main jet, #162
00-03-0116	Main jet, #165
00-03-0117	Main jet, #168
00-03-0118	Main jet, #170
00-03-0119	Main jet, #172
00-03-0120	Main jet, #175
00-03-0121	Main jet, #178
00-03-0122	Main jet, #180
00-03-0202	Main jet, #182
00-03-0123	Main jet, #185
00-03-0124	Main jet, #188
00-03-0125	Main jet, #190
00-03-0126	Main jet, #192
00-03-0127	Main jet, #195
00-03-0128	Main jet, #198
00-03-0129	Main jet, #200

High flow filter

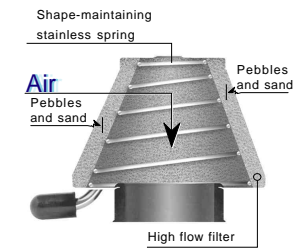

03-01-1064	for MIKUNI VM26
03-01-1094	for KEIHIN PE28

Fuel cock assembly



03-03-001

Insulator

for VM26

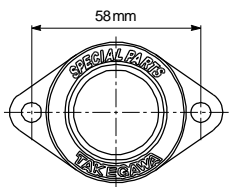

00-03-0210

for PE28

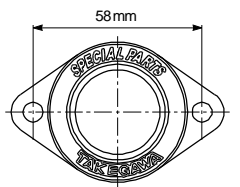

00-03-0211

Involute throttle set



Outer length: 710 mm
09-02-0230 (Black anodized)
09-02-0232 (Gray metallic anodized)
 Outer length: 810 mm
09-02-0231 (Black anodized)
09-02-0233 (Gray metallic anodized)

Standard high throttle set



09-02-0222 (710 mm in outer length)
09-02-0221 (810 mm in outer length)

90-bent high throttle set



09-02-021 (700 mm in outer length)

For more information, please refer to our parts catalog, or log onto our Web site at URL <http://www.takegawa.co.jp>

Cam shaft



- 01-08-0141** : 10 / 15D auto-decompression cam shaft
- 01-08-0142** : 15 / 20D auto-decompression cam shaft
- 01-08-0143** : 20 / 25D auto-decompression cam shaft
- 01-08-0144** : 25 / 30D auto-decompression cam shaft

As removal and installation of a cam shaft on the Super Head 4 VALVE+R is easy, we have prepared 4 kinds of cam shafts. Thus, you can enjoy the customized engine and enhanced riding comfort by selecting a desired transmission and by changing the cam shafts to meet the way of driving such as off-road driving and on-the-road driving.

Racing C.D.I. Magnet Kit



05-02-0511

Excellent startup performance because of ignition at low revolution. (Excellent start-up by a kick starter)
 Ignition timing adjustable at up to 24 degrees,
 Integral ignition coil with built-in CDI unit,
 Fully-covered stator coil to protect the ignition coil,
 Weight saving:
 R-type 58 rotor: 336 g
 Stator, including cords: 383 g
 Ignition coil, including cords: 370 g
 "ROSSA" (red) as proof of high performance
 No charging functions

Kick starter arm

(Steel-forged)

(Aluminum-forged)



02-08-0043



09-10-006

(Back step should not be installed.)

Clutch lever assembly



02-01-028 (black)
02-01-0282 (silver)

Quick lever ASSY.



02-01-0601

Steel Drive Sprocket



02-05-01 (12T Standard)
02-05-02 (13T Standard)
02-05-03 (14T Standard)



02-05-041 (15T Racing)
02-05-051 (16T Racing)

Aluminum Driven Sprocket



02-07-0635 (35T) **02-07-1225** (25T)
02-07-0638 (38T) **02-07-1228** (28T)
02-07-0641 (41T) **02-07-1230** (30T)
02-07-0642 (42T) **02-07-1233** (33T)
02-07-0643 (43T) **02-07-1235** (35T)

Steel Driven Sprocket



02-07-0007 (23T)
02-07-025 (25T)
02-07-028 (28T)
02-07-030 (23T)

Gear Ratio (Final)

Drive \ Driven	23T	24T	25T	26T	27T	28T	29T	30T	31T	32T	33T	34T	35T	36T
12T	1.91	2.00	2.08	2.17	2.25	2.33	2.42	2.50	2.58	2.67	2.75	2.83	2.92	3.00
13T	1.76	1.84	1.92	2.00	2.08	2.15	2.23	2.31	2.38	2.46	2.54	2.62	2.69	2.77
14T	1.64	1.71	1.79	1.86	1.93	2.00	2.07	2.14	2.21	2.29	2.36	2.43	2.50	2.57
15T	1.53	1.60	1.67	1.73	1.80	1.87	1.93	2.00	2.07	2.13	2.20	2.27	2.33	2.40
16T	1.43	1.50	1.56	1.62	1.68	1.75	1.81	1.87	1.93	2.00	2.06	2.12	2.18	2.25

For more information, please refer to our parts catalog, or log onto our Web site at URL <http://www.takegawa.co.jp>

Oil cooler

Compact cool





The oil "Compact Cool" is designed more compact compared to our current oil cooler and the best for mini motorcycles such as Monkey / Gorilla. The oil passage is our Standard Type and the corrugated lower fins are incorporated. This cooler body has an oil cooler plate and guard as standard equipments. In addition, the bracket mounting is integrated with the oil cooler plate so that you can use the oil outlet upside down as well.



3-Fin 4-Line AW
00-07-0055



4-Fin 5-Line AW
00-07-0008

Oil cooler		Compact cool			
Mounting Position		 Frame mount		 Steering Stem mount	
		3Fin 4Line	4Fin 5Line	3Fin 4Line	4Fin 5Line
Outlet					
 Cylinder head	Rubber hose	07-07-0041		07-07-0139	07-07-0136
	Slimline hose	07-07-0043		07-07-0138	07-07-0135
 Clutch cover	Rubber hose	09-07-2711	09-07-2712	07-07-0125	07-07-0126
	Slimline hose	09-07-2708	07-07-0107	07-07-0123	07-07-0124

Thermostat

Only for wet-type clutch cover



02-01-5052

Unusually quick response to temperature change is realized through the use of shape-memory alloy.

A relief passage can be secured via bias spring even when the oil pressure has increased because of the clogged oil cooler.

At the time of low oil temperatures, oil does not flow out to the oil cooler because the thermo unit valve closes, but it flows back to the filter through the bypass passage. When the oil temperatures rises to more than 70 degrees, the valve opens to let the oil flow to the oil cooler.

Thus, the thermo unit serves to prevent the overcooling and to keep the oil at a fixed temperature.

For more information, please refer to our parts catalog, or log onto our Web site at
URL <http://www.takegawa.co.jp>

Oil catch tank

(cylinder type)



07-05-0010

Tank capacity : 420 cc

(side cover type)



09-04-032

Tank capacity : 550 cc

Front fork



0 6 0 1 0 7 2 8

30 Front Fork Set w/Disc brake
(For 10-inch ONLY)

Our original front fork with 30 inner tube increases the stability of stroke by damping force generating mechanism of "free-valve" type and reduces the shock when the front shocks rebound and compress.

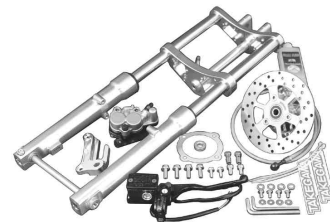

0 6 0 1 0 0 2 4

27 Front Fork Set w/Disc brake
(For 10-inch ONLY)

Our front fork increases the stability of stroke by using the damped force generating mechanism of "free-valve" type which big motorcycles have and reduces the shock when the front shocks rebound and compress.

Rear fork



0 6 0 3 0 1 0 4 Aluminum Swingarm (12cm-extended)

0 6 0 3 0 1 0 5 Aluminum Swingarm (16cm-extended)

0 6 0 3 0 1 0 7 Aluminum Swingarm(16cm-extended · With braced)

Both high rigidity and lightweight, which are both essential for swingarm, have been achieved with the well-balanced structure of our original polygon sectional design and thickness of the material.

Moreover, skillful bending and buff finish are excellent and appeal more than others.

Tubeless wheel (10-inch)

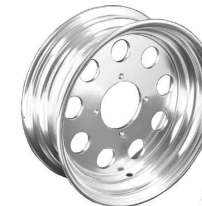

0 6 0 9 0 2 1 1 (3.5J)

0 6 0 9 0 2 1 2 (2.5J)

0 6 0 9 0 2 1 3 (2.75J)

For more information, please refer to our parts catalog, or log onto our Web site at URL <http://www.takegawa.co.jp>



0 6 0 2 0 0 1 5
Top Bridge & Stem



0 6 0 1 0 7 2 3
L / R Front Fork Set



0 6 0 2 0 0 5
27 Top Bridge



0 6 0 7 0 0 5
27 Steering Stem

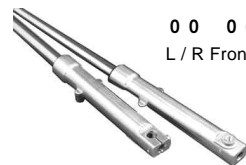

0 0 0 6 0 0 2 0
L / R Front Fork Set