

# **Engine Complete KIT : DESMO TWINCAM 4V**

Secondary kick starter engine  
DESMO-138  
TAF 5 speed (Super touring)  
Special Clutch (dry)

Item No. : 0 1 0 0 9 4 3 8

Compatible models

Monkey / Gorilla : Z50J -2000001 ~

: AB27-1000001 ~ 1899999

Thank you for purchasing our Complete Engine.

This engine is one of our Engine Complete Series which we have designed and produced by using with years of our experienced product development and manufacturing know-how.

We are proud of that we guarantee customer satisfaction with such a lightweight and high power engine.

Before installing and using this product, please check the contents of the kit, read this installation instructions carefully and understand them completely.

## Important Notice

- 1 . Please Note: Illustrations and photos may vary from actual hardware.
- 2 . The service and repair information contained in this manual is intended for use by qualified, professional technicians. Any person who does not have sufficient technique, knowledge, proper tools and equipment will never work. Be sure to ask specialty shops or professional mechanics.  
Please ask for cylinder head maintenance by our factory.  
Poor technique and lack of knowledge may cause the maintenance problems or damage parts.
- 3 . This product is intended for use ONLY in closed racing course. Never use this product on public roads.
- 4 . This kit is compatible with the above mentioned compatible models ONLY. Note: Do Not use this product for other models than listed above.
- 5 . The cylinder length of this complete engine is longer than that of the stock engine.  
It is impossible to install on stock motorcycle chassis. NOTE: Modification of the chassis is required.
- 6 . Please note that mainly because of improvement in performance, design change, and cost increase, the product specifications and prices are subject to change without prior notice. We shall be held free and harmless from any and all liabilities or claims for any defects of the parts / the product after installation, and use, and/or any other products/parts.
- 7 . We do NOT accept any claims due to the parts for racing use only. Except, any requests for the return or repair of goods purchased from TAKEGAWA must be made within one month of receipt of goods against defects in workmanship and/or materials originally caused by ONLY our failure. No returns or repairs will be accepted after one month. However, we DO NOT accept our products which are NOT installed in the right way and/or DO NOT used properly.  
We are not responsible for any expenses for repair or replacements.  
NOTE: When you use for racing, we shall be held free and harmless from any and all claims.
- 8 . These instructions should be retained along with this product.

## Read all instructions first before starting the installation.

We do not take any responsibility for any accident or damage whatsoever arising from the use of this product not in conformity with the instructions in this Manual.

While working on this product, be sure to proceed with the proper work in accordance with the instructions.

Be sure to prepare the genuine service manual of the compatible models and work as instructed. The service and repair information contained in this installation instructions and the genuine service manual are intended for use by qualified, professional technicians.

Be sure that any person who attempts service or repairs without the proper experiences, tools and equipment ask specialty shops or professional mechanics.

We shall be held free and harmless from any and all liabilities or claims for any defects of the parts/the product after installation, and use, and/or any other products/parts.

Do not use other manufacture's ignition parts, or it will cause the failure.

The necessary parts for this kit should be all TAKEGAWA-recommended parts. Always use our recommended parts.

Use TAKEGAWA-recommended fuel and engine oil.

Do not keep engine running in idle position for long period of time. It exceeds engine temperature, which cause the damage of the engine.

 **CAUTION** The following show the envisioned possibility of injuries to human bodies and property damage as a result of disregarding the following cautions.

- This Kit is designed for closed course competition purposes only. So please do not drive on a public road after the installation of this Kit.
- Before starting the installation, make sure the engine and muffler are cool at below 35 degrees Celsius. (Otherwise, you will burn you.)
- Prepare right tools for the work. (Otherwise, the installation with improper tools could cause breakage of parts or injuries to you.)
- As some products and frames have sharp edges or protruding portions, please work with your hands protected. (Otherwise, you will suffer injuries.)
- Always use new gaskets, seals and the like. The continued use of the worn or damaged ones will cause engine trouble.

 **WARNING** The following show the envisioned possibility of human death or serious injuries to human bodies as a result of disregarding the following warnings.

- Those who are technically unskilled or inexperienced are required not to do the work. (Improper installation because of insufficient skill or knowledge could lead to parts breakage and subsequently to accidents.)
- Before doing work, place the motorcycle on level ground to secure your motorcycle for safety's sake. (Otherwise, your motorcycle could overturn and injure you while you are working.)
- Always start the engine in a well-ventilated place, and do not turn on the engine in an airtight place. (Otherwise, you will suffer from carbon monoxide poisoning.)
- As gasoline is highly flammable, never place it close to fire. Make sure that nothing flammable is near the gasoline. (Otherwise it may cause a fire.)
- Tighten to a specified torque using a torque wrench. (Otherwise, improper tightening may cause the bolts or nuts to get damaged or come off, leading to accidents.)
- Never use the parts unspecified by us. (This may lead to parts breakage and consequent accidents)
- If you find damaged parts when checking and performing maintenance of your motorcycle, do not use these parts any longer, and replace them with new ones.  
(The continued use of these damaged parts as they are could lead to accidents.)
- When you notice something abnormal with your motorcycle while riding, immediately stop riding and park your motorcycle in a safe place to check what has gone wrong.  
(Otherwise, the malfunction could lead to accidents.)
- Carry out inspection and maintenance of your motorcycle correctly according to the instructions and guidelines in the service manuals. (Use TAKEGAWA-recommended fuel and engine oil.)
- Fuel must always be high-octane gasoline. (Otherwise, troubles such as engine knocking may cause accidents.)
- When driving a bike, a driver must always wear a helmet securely. Otherwise, the driver is likely to be subject to death or serious injury in an accident.

## Features

### About our DESMO head

Most 4 stroke combustion engines use a camshaft and a valve spring to open and close the valves, but the DESMO structure uses a specially shaped camshaft that forces the valve open and shut.

Thus, since it does not use a valve spring, there is no surging of the valve spring when driving at high speeds.

And another special feature is the very small amount of friction exerted on the camshaft.

The cylinder head uses a twin cam of 4 valves, so the intake valve diameter is 22mm and the exhaust valve diameter is 19mm.

Within the limited space of the horizontal engine, 8 rocker arms and 2 camshafts are distributed like a precision instrument, providing proof-positive of the technical power of our company.

In addition, we have tested a large number of combustion chambers of differing shapes, and we have utilized the shape with the highest efficiency ratio.

Mutual compatibility of the exhaust port and the exhaust system has been achieved by using the same as our Super Head and stock head.

In addition, the cam gear related parts and the intake manifold are also compatible with the present DOHC engine.

### Use of Plated Cylinder:

This cylinder is aluminum one-piece construction and the ceramic chrome plated inner wall allows the additional wear-resistance and the reduced friction loss. It also features both high gas tightness and durability.

### Use of Oil Jet:

We have installed the oil jet which works to jet-spray the oil to the rear side of the piston from crankcase oil line in order to cool the piston.

### Dry Clutch System.

To hold and transfer the engine power, 5 plate clutch disc and outer unit directly mounted to the main shaft.

This is the most reliable method and a great throttle responses at the same time. Equipped paper type cartridge oil filter. Optional oil cooler outlet adaptor is available.

Newly designed clutch disc judder spring and seat prevents variation minimal.

### Use of close ratio transmission:

The close ratio transmission is designed to enable smooth shift up and down and cornering, and, moreover, effective transmission of engine power.

### Use of Lightweight Outer Rotor ACG

SS-outer rotor is equipped as standard .Rotor body is a compact design and it weighs 536g. The best ignition timing is set up exclusively for this complete engine and the quick response has been achieved.

~ Kit contains ~

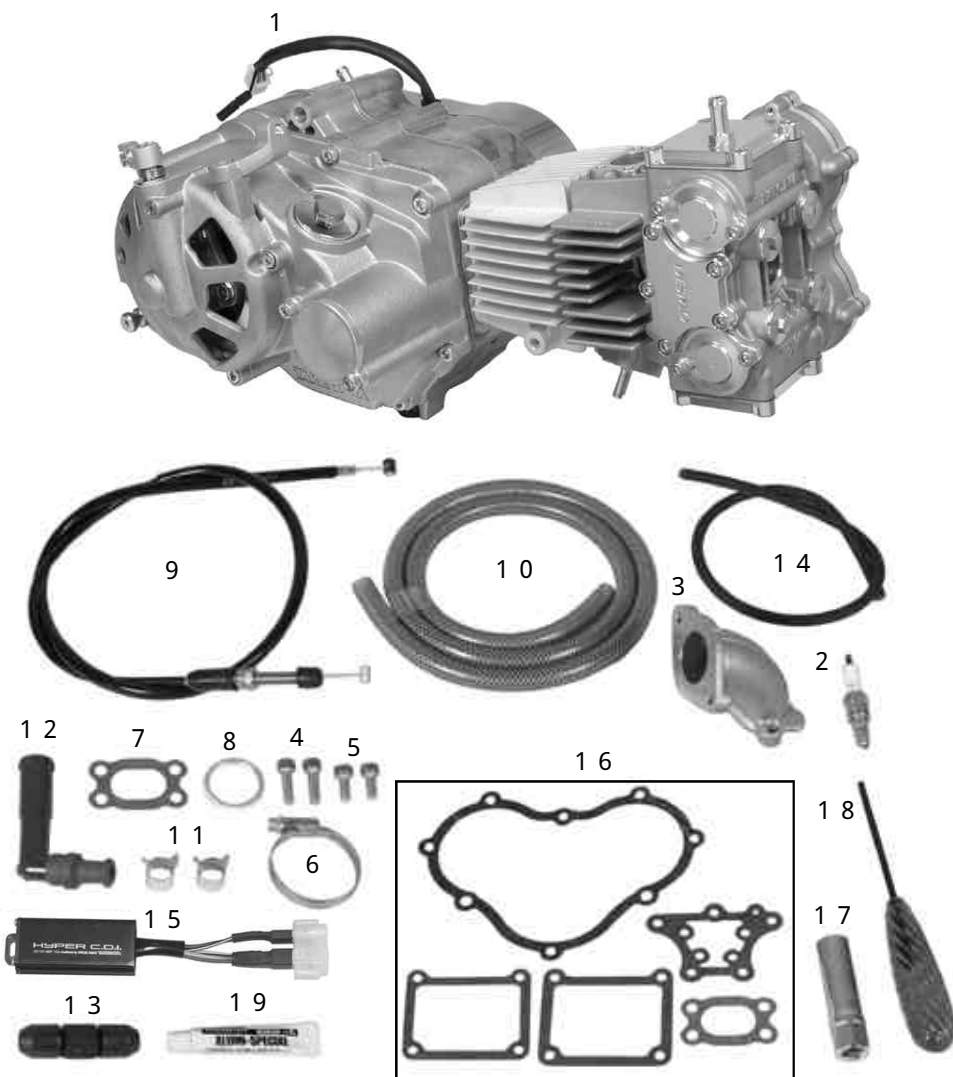

No.	Part Name	Qty	Repair Part Item No.	In packs of
1	Engine COMP.	1	_____	_____
2	Spark plug, ER8EH	1	NGK-ER8EH	1
3	Intake manifold	1	06171-D4H-T00	1
4	Socket cap screw, 6 x 20	2		2
5	Socket cap screw, 6 x 15	2		2
6	Norma Torro Band	1		1
7	Inlet pipe gasket	1		1
8	Exhaust pipe gasket	1	00-01-0064	2
9	Clutch cable COMP., 910 mm	1	00-02-0107	1
10	Braided hose, 8 x 1 m	1	00-07-0070	1
11	Hose clamp, 13.1	2		2
12	Spark plug cap COMP.	1	00-01-1051	1
13	Plug wire connector	1	00-01-1012	1
14	Spark plug wire, 500 mm	1	00-01-1043	1
15	Hyper CDI	1	05-03-0003	1
16	Head cover gasket set	1	06111-DSM-T00	1
17	Plug socket, 13mm	1	00-00-0247	1
18	Ball point driver, 4 mm	1	_____	_____
19	Alumi special (5 g)	1	00-01-0001	1

Please order repair parts with the Repair Part Item No. Without the repair part item NO., we may not be able to accept your orders.

Some parts are only available as a set. In this case, please order them with the set number.

## Main Reference Value

Type	4-cycle gasoline
Displacement	137.8cc
Number of cylinder and arrangement	Horizontal single cylinder
Cooling method	Air-cooling
Valve train	DOHC(desmodromic) valve, chain / gear drive.
Chamber design	Pentroof (Hemispherical) type
Bore and Stroke	57mm x 54mm
Compression ratio	11.6 : 1
Camshaft type	Intake 25 Exhaust 25
Valve timing:	(1mm lift)
Intake open	20 ° BTDC
closed	50 ° ABDC
Exhaust open	55 ° BBDC
closed	15 ° ATDC
Lubricating method	Combined use of force feed system & splash lubrication system
Pump type	Trochoid type
Capacity	0.8 liter
Fuel to be used	High-octane gasoline ( research method: over 97 octane value)
Ignition system	C.D.I. ignition
Spark plug	NGK-ER8EH
Starting method	Kickstarter system
Power transmission	
Clutch	Dry multi-disk
Operating mode	Mechanical
Transmission	
Type	Constant mesh, 5-speed return
Gear ratio	
1st speed	2.357 (33 / 14)
2nd speed	1.611 (29 / 18)
3rd speed	1.190 (25 / 21)
4th speed	0.958 (23 / 24)
5th speed	0.807 (21 / 26)
rear-wheel-drive mechanism	
Type	Chain drive

## Inspect and Adjust

Items	Frequency	Refer to page
Clean and Inspect Spark Plug	Every 2000km	P-C1
Inspect Valve Clearance	Every 500 ~ 600km	
Change Engine Oil	Every 1000 ~ 2000km	P-C1
Adjust and Inspect Carburetor	Each time	Depend on Carburetor type
Replace Oil Filter	Every 1500 ~ 2000km	P-C2
Adjust Clutch Cable	Every 250km	P-C2
Inspect Clutch Friction Disc	Every 1000km	See Service Manual
Inspect Piston and Piston Ring	Every 1000km	See Service Manual
Inspect Piston Pin	Every 2000km	See Service Manual
Inspect Crankshaft	Every 1000km	See Service Manual
Inspect Cylinder Head and Cylinder	Every 2500km	See Service Manual
Inspect Crankcase	Every 2000km	See Service Manual

Maintenance period in the table is a guideline. You might need to work more frequently depending on the motorcycle usage or condition.

We recommend more frequently maintenance than the maintenance period.

## ~ Precautions of Use ~

### About the specifications of motorcycle to equip

The cylinder length of this complete engine is longer than that of the stock engine.  
 It is impossible to install on stock motorcycle chassis. NOTE: Modification of the chassis is required.  
 For Monkey / Gorilla, modify the chassis if necessary after checking whether the installation is possible referring to the following parts and optional parts of P-D1 ~ D4.

Compatible Specifications Data Chart		
Front Fork	Stock fork (Inapplicable) × Spec Modification	Our 30 Upright Front Fork (See P-D4)
Tyre	—————▶	Larger wheel (10-inch) is recommended according to the power increase.
Top Bridge / Steering stem	Stock fork (Inapplicable) × Spec Modification	Our Top Bridge & Stem Kit or Front Fork Kit 60mm Offset (See P-D4)
Rear Fork	—————▶	We recommend the modification to match the front fork and tire size. (See P-D4)
Oil cooler	—————▶	We recommend to use it according to the heat increase. (See P-D3)
Drive / Driven sprocket	Stock (Inapplicable) × Spec Modification	Final Gear Ratio 2.188 ~ 2.063 (for 10-inch) (See P-D2)
Oil catch tank	Need to Install	Equipped as necessary (See P-D4)

### About fuel:

Whenever regular gasoline is remaining in the fuel tank, always replace it with high-octane gasoline.

### About oil cooler:

The installation of this product increases the heat release value of the engine, set off by the increase in power. We recommend you, therefore, to install an oil cooler kit, for a long-time high-load running, which keeps oil at appropriate temperatures and prevents such troubles as oil film shortage at high temperatures.

In case you use the breather cap, be sure to use an oil catch tank at the same time.  
 Due to large displacement engine, blow- by gas volume may increase. Larger capacity catch can are highly recommended. (approx 500 cc)

### About upper limit of revolution:

Max rpm may vary by the camshaft and engine specification, always use taco meter to avoid over-rev the engine rpm.

124cc : Intake camshaft : 25  
           Exhaust camshaft : 20  
           Maximum rpm : 12000 rpm

138cc : Intake camshaft : 25  
           Exhaust camshaft : 25  
           Maximum rpm : 11500 rpm

Take note that engine racing and sudden acceleration, particularly in the 1st or 2nd gear, tend to exceed the upper limit of revolutions.

Over revolutions will result in nonsmooth revolutions of the engine, not only adversely affecting the engine life, but also possibly breaking the engine in the worst case.

An Engine NO. (Serial No.) is stamped on this engine as identification.  
 Please specify your Engine NO. when ordering repair part or contacting us.

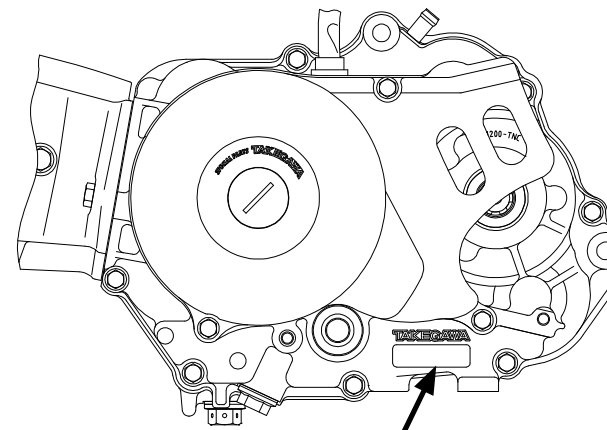

Engine No. stamped here.  
 2SMS-20001 ~

### Rearsets:

To use rearsets, you may need to modify the drive sprocket cover.

**SPECIAL PARTS TAKEGAWA Co.,Ltd.**  
 3-5-16 Nishikiorihigashi Tondabayashi Osaka Japan TEL : 81-721-25-1357 FAX : 81-721-24-5059 URL : <http://www.takegawa.co.jp>

## ~ Installation Instructions ~

Before starting the installation, please prepare the relative service manual and necessary tools for the motorcycle.

And prepare necessary optional parts as well. For details, please see the attached sheets.

Caution: This installation instructions are for the models which this complete engine can be equipped.

Please Note: Illustrations and photos may vary from actual hardware.

### Remove the engine

Remove the engine and carburetor from the motorcycle referring to the service manual of your vehicle.

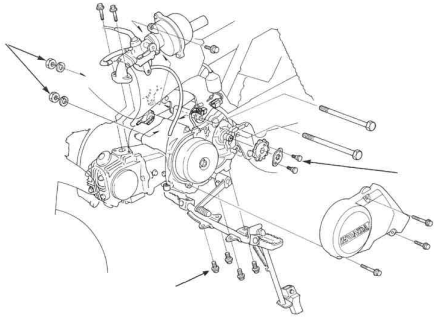

### Installation of engine

Install the engine COMP. to the frame referring to the relative service manual for the motorcycle.

⚠ Caution : Be sure to follow the specified torque.  
 ⚠ Warning : Do follow the instructions in the service manual.

**20 ~ 25N·m(2.0 ~ 2.5kgf·m)**

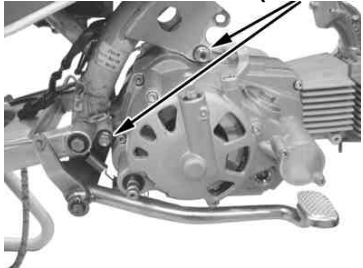

⚠ Caution : Be sure to follow the specified torque.  
**Torque: 20 ~ 25N·m (2.0 ~ 2.5kgf·m)**

### Connect ACG

Replace the CDI with the supplied CDI referring to the service manual of your vehicle.

Connect the wire from Engine COMP and the coupler from the motorcycle.

If you set up the main wire harness as a racing purpose, connect the wires referring to the attached wiring diagrams.

(See P-B6)

For those who ordered without ACG

- Remove the generator cover and install the generator and flywheel following the instructions of your ignition parts.

### Installation of clutch cable:

Attach a clutch cable to the clutch lever, and route the cable to the clutch cable receiver, being careful not to stretch it too tight.

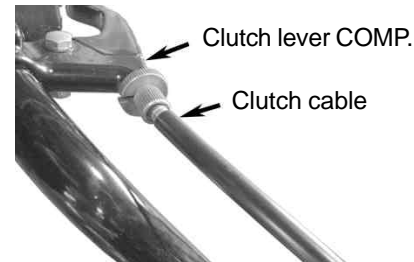

Install clutch cable receiver to the clutch cover with cap screw (6x15)

⚠ Caution : Be sure to follow the specified torque.  
**Torque: 10 N·m (1.0 kgf·m)**

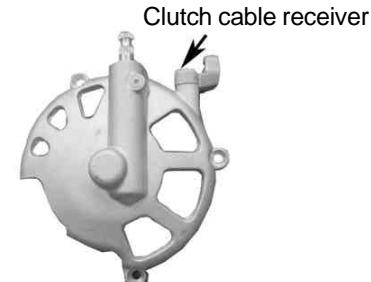

Install cable on the receiver.

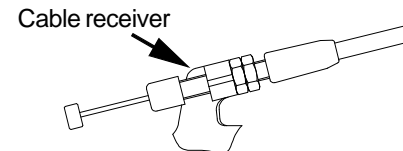

Install release arm with spring cable on the clutch pinion, (use washer)  
 Release arm must be install with fully pulled position.

Be sure the side of the release arm.  
 Adjust free play properly.

⚠ Caution : Be sure to follow the specified torque.  
**Torque: 10 N·m (1.0 kgf·m)**

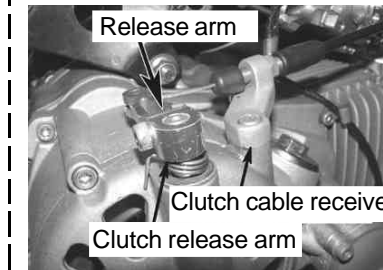

Attach the flange bolt to the release arm, and tighten the bolt to the specified torque, pressing the arm.

⚠ Caution : Be sure to follow the specified torque.  
**Torque: 10 N·m (1.0 kgf·m)**

Adjust the free play at the clutch with the adjuster on the clutch cable, then tighten the locking nuts to the specified torque, and cover the clutch cable adjusters at both ends with rubber caps.

⚠ Caution : Be sure to follow the specified torque.  
**Torque: 10 N·m (1.0 kgf·m)**

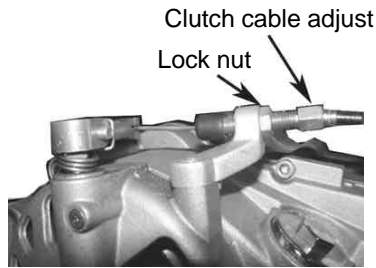

Clutch free play :  
 10 to 20 mm at the clutch lever end

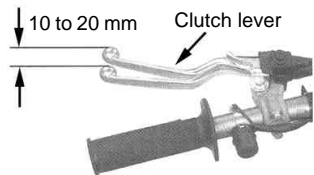

**Inspection:**

With the engine turned off, shift the transmission to the first gear. Then, check that the rear wheel rotates when you move the machine, squeezing the clutch lever, and that the rear wheel does not rotate when you have released the clutch lever.

**Installation of carburetor:**

Route the supplied throttle cable along the frame just like the stock throttle cable was routed.

Pass the throttle cable through the lower throttle housing, and connect the inner cable to the throttle pipe.

And attach the throttle housing to the steering handle. Apply grease to the rubbing surface of the throttle pipe, cable end and the cable taking-up portion on the pipe.

Put a inlet pipe gasket between the cylinder head and the inlet pipe, and tighten it with 6x20 socket cap screw to the specified torque.

⚠ Caution : Be sure to follow the specified torque.  
**Torque: 10 N·m (1.0 kgf·m)**

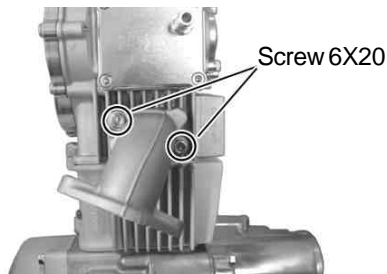

Fasten the carburetor insulator, to be used on the inlet pipe, with the supplied two socket cap screws.

⚠ Caution : Be sure to follow the specified torque.  
**Torque: 10 N·m (1.0 kgf·m)**

In the case of PE28:

Fits only the Monkey  
 NOT installable onto the Gorilla

Remove a float chamber, and then a main jet. Attach a supplied main jet #110 and slow jet #35, and then a float chamber.

Detach a top cover of the supplied carburetor, and pull out the spring and throttle valve.

Pass the inner cable of the throttle cable through the carburetor top cover and then through the spring. And compressing the spring, fix the top cover and all to the throttle valve. Fix the throttle valve to the carburetor by aligning a notch on the throttle valve with the throttle stop screw.

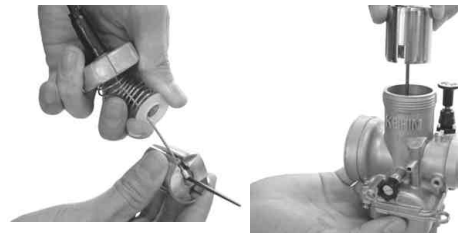

Insert the carburetor into the insulator, and fasten them with a clamp band.

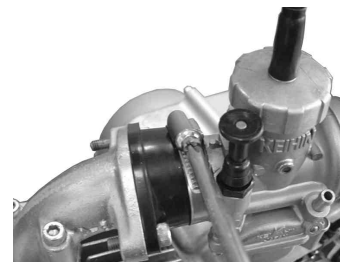

Attach an air filter, which please secure by tightening a band.

Adjust the free play at the throttle grip to be about 5 mm by turning the adjuster of the throttle cable.

Follow the instructions of your throttle cable to adjust the free play.

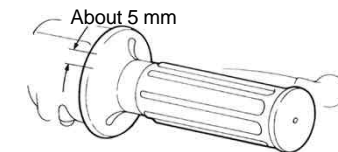

Snap the throttle a few times to make sure that the throttle moves smoothly without sticking and that the throttle valve is fully open. And check that the throttle has free play even when a steering handle is turned all the way to the right or to the left. Insert a fuel tube and fasten it with a tube clip. Open the fuel cock and check for oil leaks.



In the case of VM26:

Remove the top cover from the carburetor, and pull out the spring and the throttle valve.

Pass the inner cable of the throttle cable through the carburetor top cover and then through the spring. And compressing the spring, fix the top cover and all to the throttle valve. Fix the throttle valve to the carburetor by aligning a notch on the throttle valve with the throttle stop screw.

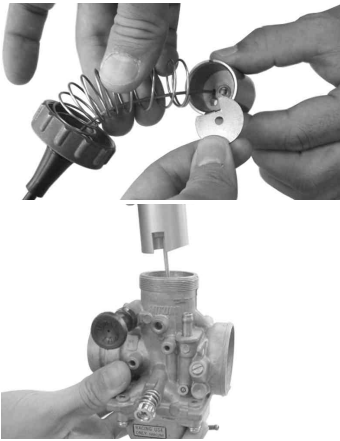

Insert the carburetor into the insulator, and fasten them with a clamp band.



Attach an air filter, which please secure by tightening a band.

Adjust the free play at the throttle grip to be about 5 mm by turning the adjuster of the throttle cable. Follow the instructions of your throttle cable to adjust the free play.

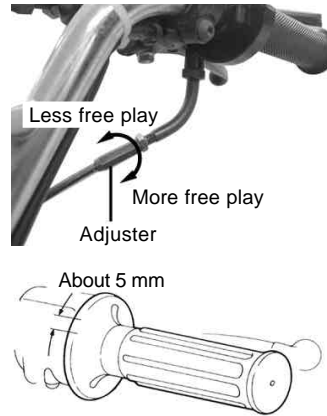

Snap the throttle a few times to make sure that the throttle moves smoothly without sticking and that the throttle valve is fully open. And check that the throttle has free play even when a steering handle is turned all the way to the right or to the left.

In the case of installation to any model of the Gorilla, replace the pre-installed fuel cock with the supplied cock. Adjust the direction of the fuel cock and fasten the nut to the fuel tank.

**⚠ Caution :** Be sure to follow the specified torque.  
**Torque: 5 ~ 6N·m (0.5 ~ 0.6 kgf·m)**



Insert a fuel tube and fasten it with a tube clip. Open the fuel cock and check for oil leaks. (Do not leave the cock open for many hours.)

Dispose of the blow-by gas from the crankcase by yourself.

(Some races and regulations stipulate the blow-by gas disposal.)

In sending back the blow-by gas to the carburetor, connect the blow-by hose with the union on the air-filter.

(See Optional parts chart on P-D1)

## Engine oil

Remove the cap and add 850cc of engine oil.



Referring to the chart below, choose the engine oil whose viscosity matches the region and outside temperature.

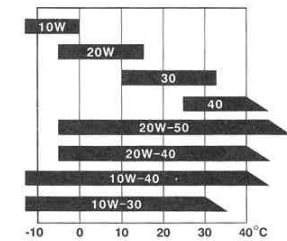

Install the oil inlet cap.

Install an optional kick starter arm.



### Installation of drive chain

Remove generator cover.(5 bolt)

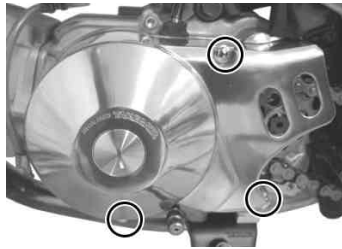

Install the drive sprocket.

⚠ Caution : Be sure to follow the specified torque.  
**Torque: 12 ~ 15N·m (1.2 ~ 1.5 kgf·m)**

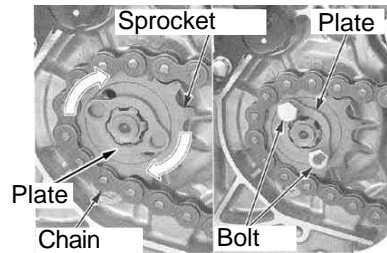

Install the drive chain referring to a genuine service manual or instruction manual for the relative rear fork.

⚠ Warning : Do follow the instructions in the service manual.

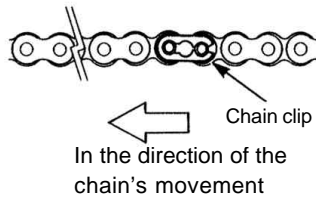

Install the change pedal.

⚠ Caution : Be sure to follow the specified torque.

### Install the exhaust system

Attach a supplied exhaust pipe gasket to the exhaust port.



Install an exhaust muffler according to the installation instructions of the relative exhaust muffler.

### Start engine

Check that the ignition key and gas cock are turned off.

Keep kicking the starter for a while till the engine oil circulates all around the engine.

Install the spark plug. Lightly apply the "Aluminum Special", the heat-resistant lubricating agent, to the threaded portion on the plug. And tighten the plug.

⚠ Caution : Be sure to follow the specified torque.  
**Torque: 8 ~ 10 N·m (0.8 ~ 1.0 kgf·m)**

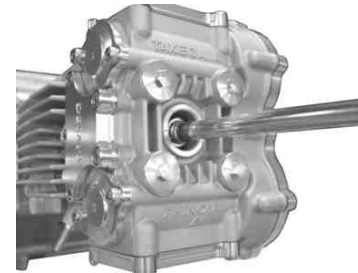

Attach the plug cap to the spark plug.

Thoroughly wipe off dirt and dust on the engine.

Turn on the gasoline cock and the ignition key.

Pull a choke lever to start the engine.

Gradually loosen your grip on the lever, and warm up the engine till the revolution becomes smooth.

And then return the lever fully back to its original location.

If the engine does not run idle after warming-up, or it runs idle at high revolutions, adjust the revolutions with the throttle stop screw.

Stop the engine once.

Wait for a few minutes and keep the motorcycle level to the ground, and then check the oil amount with oil level gauge on right crankcase.



Always keep the oil to the specified level.  
(Use the same grade and brand oil.)

Check for malfunctions such as unusual sounds. If no malfunction is detected, do the setting of the carburetor.

(See the attached sheet)

⚠ Warning : Be sure to do the work in a well-ventilated place.

Carry out again a shakedown up to about 50 to 100 km.

After the shakedown, check for malfunctions such as unusual noises or blow-by gas.

(If there is any malfunction, disassemble the engine again to check each part.)

⚠ Caution : Never reuse parts which are not suitable for reuse.

⚠ Warning: Those who are technically unskilled or inexperienced are required not to do the work.

## Relevance of Front Fork and Tire

### 30 Upright Front Fork

Clamp the top bridge at the highest point of the straight portion to avoid the tapered portion of front fork.

Before installing, make sure that no interference occurs when the front fork is fully bottomed.

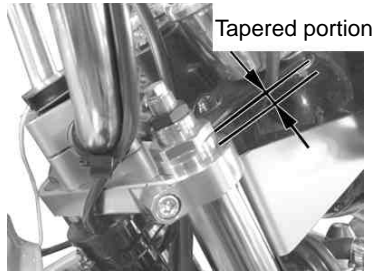

Generator side		Bike side		機能	Function
黄1	Yellow 1	黄	Yellow	灯火用AC出力 (AC電源用)	Lighting AC output (for AC power)
黄2	Yellow 2	白	White	灯火用AC出力 (DC電源用)	Lighting AC output (for DC power)
緑	Green	緑	Green	メインアース (GND)	Main GND
青/黄	Blue/Yellow	青/黄	Blue/Yellow	パルスジェネレーター信号	Pickup pulse
黒/赤	Black/Red	黒/赤	Black/Red	点火用AC出力	Ignition AC output
若葉/赤	Light Green/Red	若葉/赤	Light Green/Red	ニュートラルスイッチコード	Neutral Switch

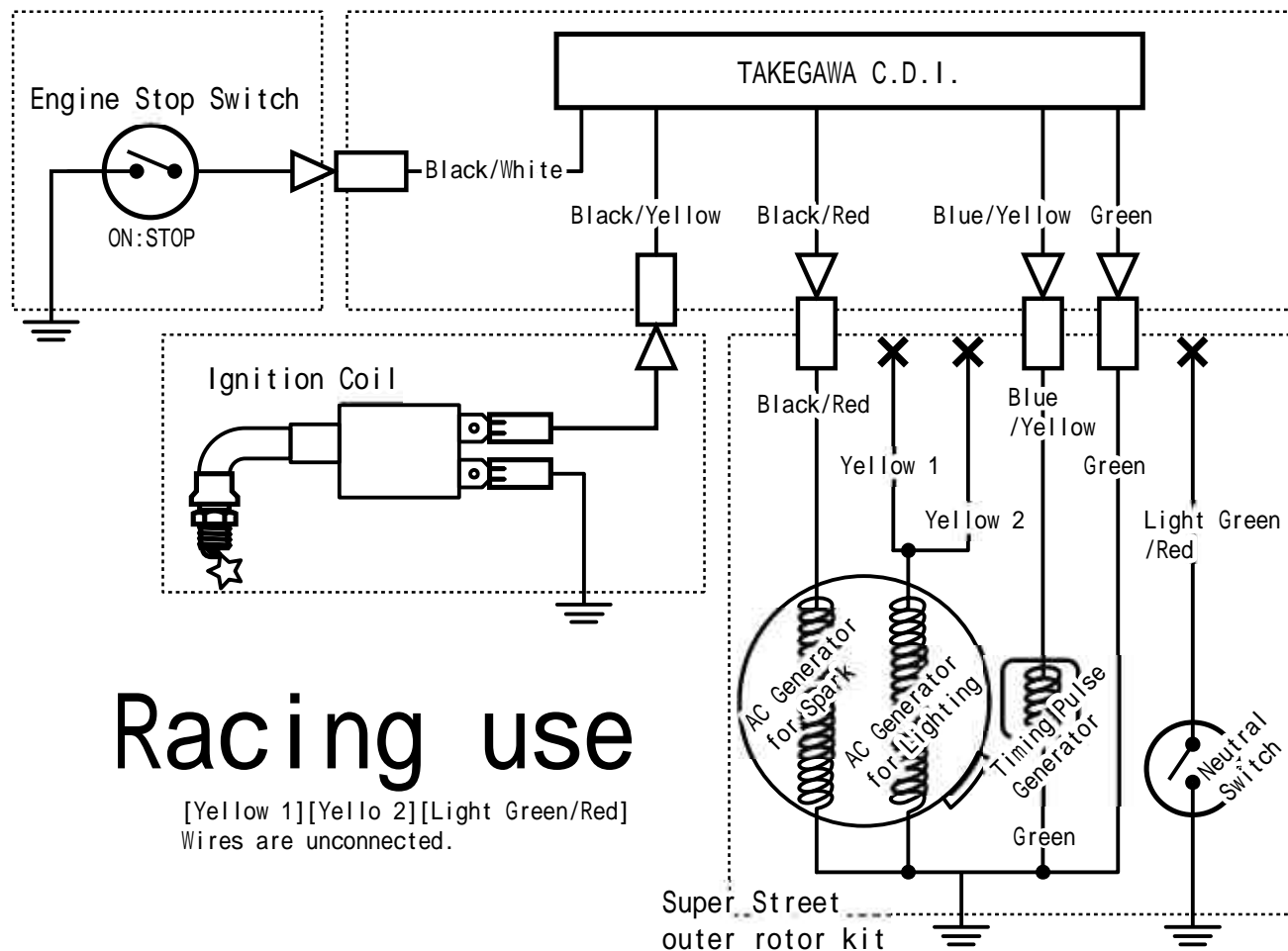

# Racing use

[Yellow 1][Yellow 2][Light Green/Red]  
Wires are unconnected.

## ~ Inspections and Adjustments ~

**CAUTION** Be sure to use a torque wrench and strictly keep the specified torque.

**WARNING** The inspections and adjustments are intended for use by qualified professional mechanics. Be sure that any person who does not have the proper technique, experiences and knowledge will never work.

### Spark plug:

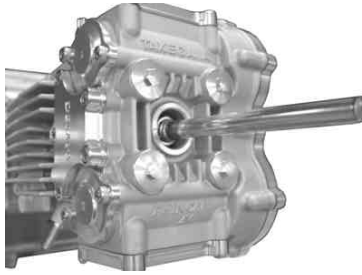

Detach a plug cap, and then a spark plug with a plug wrench.

With a wire brush or a plug cleaner, clear the plug electrode section of the accumulated residues. Check the plug gap with a thickness gauge. And when the gap deviates from the benchmark, adjust it by bending the electrode section.

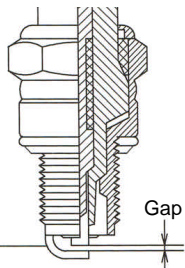

**Gap**  
Benchmark : 0.6 ~ 0.7 mm

Check if the electrode section is worn out, corroded or burnt-out, or its insulator is damaged. When necessary, change the spark plug. With a wire brush or a plug cleaner, clear the plug electrode section of the accumulated residues. Check the plug gap with a thickness gauge. And when the gap deviates from the benchmark, adjust it by bending the electrode section.

#### Standard

• NGK : ER8EH

#### Plug with high thermal value (Cold type)

• NGK : ER9EH

Apply a small amount of ALUMI SPECIAL on screws of spark plug. Tighten the spark plug and install the plug cap.

**Caution** : Be sure to follow the specified torque.

### Oil Change:

Warm up the engine within a few minutes to normal operating temperature.

Prepare an oil container under the drain bolt.

And drain the oil while the engine is warm.



Install the drain bolt, and tighten it to the specified torque.

**Caution** : Be sure to follow the specified torque.  
**Torque: 19.5 ~ 24.5 N · m (2.0 ~ 2.5 kgf · m)**

Remove the cap of oil inlet and add 750cc of engine oil.



Add the engine oil in the specified amount.

#### Recommended oil:

SAE 10W - 40 20W - 50

API class, SF grade engine oil

#### Oil amount:

When oil change ONLY : 750cc

When rebuilt the engine : 800cc

Referring to the chart below, choose the engine oil whose viscosity matches the region and outside temperature.

Relationship between temperatures and viscosity

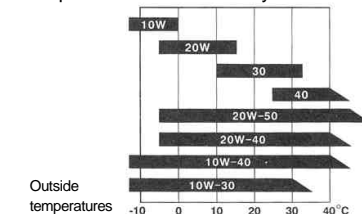

Install the oil inlet cap.

Warm up the engine within a few minutes to normal operating temperature.

Stop the engine once. Wait for a few minutes and keep the motorcycle level to the ground, and then check the oil amount with oil level gauge on right crankcase.

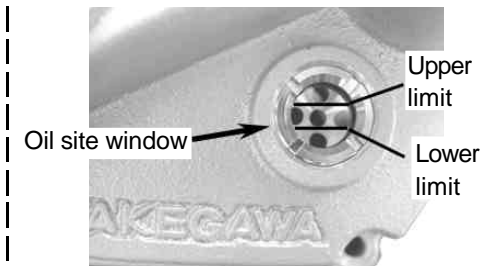

Always keep the oil to the specified level. (Use the same grade and brand oil.)

### Change of Oil filters:

Unfasten two bolts on the oil filter cover, and detach the oil filter cover, oil filter and oil filter spring.



Check the O-ring in an oil filter cover, and change it when necessary.

Attach a new oil filter to the filter cover.

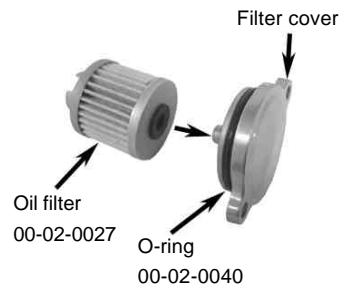

Place the oil filter spring at the protrusion on the right side crankcase cover.

Apply a thin coat of engine oil to the O-ring on the oil filter cover, attach an oil filter and oil filter cover, and tighten two bolts to the specified torque.

⚠ Caution : Be sure to follow the specified torque.

**Torque: 10 N · m(1.0 kgf · m)**

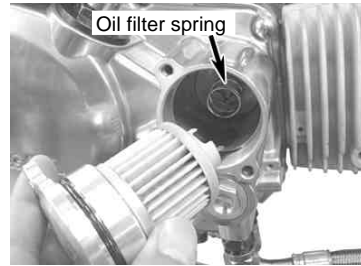

# How to Set the Carburetor

- When the carburetor does not match the engine and the engine fails, the engine failures are caused by either too dense or too lean air-fuel mixture.
- The engine failure symptoms for the engine are as follows:

When the air-fuel mixture is too dense:	When the air-fuel mixture is too lean:
<ul style="list-style-type: none"> <li>• The explosion sound with a dull thud continues intermittently.</li> <li>• The engine malfunctions further if you use the choke.</li> <li>• The engine malfunctions when you warm it up.</li> <li>• The engine works well if the cleaner is detached.</li> <li>• The motorcycle belches dense (or, black) exhaust gas.</li> <li>• The plug smolders, getting blackened.</li> </ul>	<ul style="list-style-type: none"> <li>• The engine overheats somewhat.</li> <li>• The engine starts working well If you use the choke,.</li> <li>• The engine does not accelerate well. (No smooth acceleration)</li> <li>• Revolutions change, generating weak power.</li> <li>• The plug burns white.</li> </ul>

Set the carburetor only after warming up the engine, and then test-drive. And use a plug with the right heat value.

Do the setting in the following manner, studying at what throttle opening position the engine starts failing.

## Jet needle (Throttle position at 1/4 - 3/4)

Whether or not the engine revolution is in proportion to the throttle operation

- When the acceleration is not smooth or even, make the air-fuel mixture dense.
- Make the air-fuel mixture lean when the engine revolution goes up heavily and belches black gas.

The mixture ratio at this throttle position can be adjusted by the location of E-ring in the grooves.

The air-fuel mixture becomes dense as the location of the E-ring moves down from the 1st to the 5th groove.

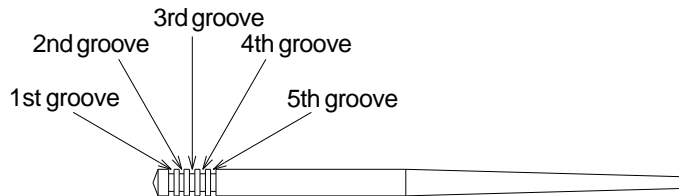

## Main jet (The throttle position at 3/4 - 4/4)

The air-fuel mixture ratio at this throttle position can be adjusted by changing the number of the main jet.

The larger the main jet numbers, the denser the mixture ratio becomes.

In view of the engine and muffler specifications, select the most appropriate main jet to get the highest revolutions.

## Pilot jet (First of all, please adjust the air screw.)

- In case you have given more than three turns to the air screw to tighten it, use a pilot jet with a small number.
- If you have tighten the air screw (clockwise) to the full, use a pilot jet with a larger number.
- Check whether you have made a right choice of the pilot jet by seeing if the engine starts up revolving smoothly from the idling to running at slow speed.
- When the engine revolves up unevenly, the pilot jet number is too small. (At idle)
- When the motorcycle belches black exhaust gas and produces heavy exhaust sound, the pilot jet number is too big. (At idle)
- After replacing the pilot jet, you need to readjust the airscrew.

## Air screw

The air screw adjusts the air mass flow at the time of engine's revolving at slow speed. (At idling)

- Give the air screw a right turn The air-fuel mixture gets dense.
- Give the air screw a left turn The air-fuel mixture gets lean.

Loosen the tightened air screw back to the 1.5-turn position. And then from this position, give to the airscrew a right or left turn of 1/4 to 1/2 till the engine revolves at the highest speed.

Loosen the idle stop screw till you get the steady idling revolutions. And once again adjust the position of the airscrew to get the highest revolutions.

## On how the barometric pressure, temperatures and humidity affect the setting:

- At highlands or at high altitudes, the barometric pressure and air density go down and the air gets into the carburetor in less amounts.
- This makes the air-fuel mixture dense which was adjusted at low altitudes.
- Under the weather conditions with very low temperatures, the air density increases, which makes the air-fuel mixture lean.
- Under the rainy and humid weather conditions, the air density decreases, which makes the air-fuel mixture dense.

Please be informed that, mainly because of improvement in performance, design changes, and cost increase, the product specifications and prices are subject to change without prior notice.

This manual should be retained for future reference.

## VM26 Carburetor

Item Nos	Product Names
00-03-0151	Pilot jet, # 10
00-03-0152	Pilot jet, # 12.5
00-03-0153	Pilot jet, # 15
00-03-0154	Pilot jet, # 17.5
00-03-0155	Pilot jet, # 20
00-03-0156	Pilot jet, # 22.5
00-03-0157	Pilot jet, # 25
00-03-0158	Pilot jet, # 27.5
00-03-0159	Pilot jet, # 30



03-03-0321

Item Nos	Product Names
00-03-0060	Main jet, # 100
00-03-0061	Main jet, # 105
00-03-0062	Main jet, # 110
00-03-0063	Main jet, # 115
00-03-0064	Main jet, # 120
00-03-0065	Main jet, # 125
00-03-0066	Main jet, # 130
00-03-0067	Main jet, # 135
00-03-0068	Main jet, # 140
00-03-0069	Main jet, # 145
00-03-0070	Main jet, # 150
00-03-0071	Main jet, # 155
00-03-0072	Main jet, # 160
00-03-0073	Main jet, # 165
00-03-0074	Main jet, # 170
00-03-0075	Main jet, # 175
00-03-0076	Main jet, # 180
00-03-0077	Main jet, # 185
00-03-0078	Main jet, # 190
00-03-0079	Main jet, # 195
00-03-0080	Main jet, # 200
00-03-0081	Main jet, # 210
00-03-0082	Main jet, # 220
00-03-0083	Main jet, # 230
00-03-0084	Main jet, # 240
00-03-0085	Main jet, # 250
00-03-0086	Main jet, # 260

## PE28 Carburetor

Item Nos	Product Names
00-03-0137	Slow jet, 35
00-03-0138	Slow jet, 38
00-03-0139	Slow jet, 40
00-03-0140	Slow jet, 42
00-03-0141	Slow jet, 45
00-03-0142	Slow jet, 48
00-03-0143	Slow jet, 50
00-03-0144	Slow jet, 52
00-03-0145	Slow jet, 55
00-03-0146	Slow jet, 58
00-03-0147	Slow jet, 60
00-03-0148	Slow jet, 62
00-03-0149	Slow jet, 65
00-03-0150	Slow jet, 70



03-03-027

Item Nos	Product Names
00-03-0130	Main jet, #82
00-03-0131	Main jet, #85
00-03-0132	Main jet, #88
00-03-0133	Main jet, #90
00-03-0134	Main jet, #92
00-03-0135	Main jet, #95
00-03-0136	Main jet, #98
00-03-0090	Main jet, #100
00-03-0091	Main jet, #102
00-03-0092	Main jet, #105
00-03-0093	Main jet, #108
00-03-0094	Main jet, #110
00-03-0095	Main jet, #112
00-03-0096	Main jet, #115
00-03-0097	Main jet, #118
00-03-0098	Main jet, #120
00-03-0099	Main jet, #122
00-03-0100	Main jet, #125
00-03-0101	Main jet, #128
00-03-0102	Main jet, #130
00-03-0103	Main jet, #132
00-03-0104	Main jet, #135
00-03-0105	Main jet, #138
00-03-0106	Main jet, #140

Item Nos	Product Names
00-03-0107	Main jet, #142
00-03-0108	Main jet, #145
00-03-0109	Main jet, #148
00-03-0110	Main jet, #150
00-03-0111	Main jet, #152
00-03-0112	Main jet, #155
00-03-0113	Main jet, #158
00-03-0114	Main jet, #160
00-03-0115	Main jet, #162
00-03-0116	Main jet, #165
00-03-0117	Main jet, #168
00-03-0118	Main jet, #170
00-03-0119	Main jet, #172
00-03-0120	Main jet, #175
00-03-0121	Main jet, #178
00-03-0122	Main jet, #180
00-03-0202	Main jet, #182
00-03-0123	Main jet, #185
00-03-0124	Main jet, #188
00-03-0125	Main jet, #190
00-03-0126	Main jet, #192
00-03-0127	Main jet, #195
00-03-0128	Main jet, #198
00-03-0129	Main jet, #200

## High flow filter

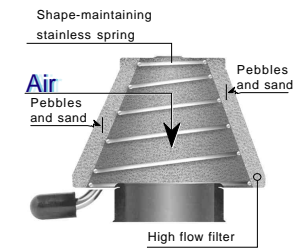

03-01-1064	for MIKUNI VM26
03-01-1094	for KEIHIN PE28

## Fuel cock assembly



03-03-001

## Insulator

for VM26

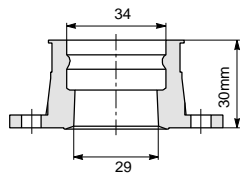
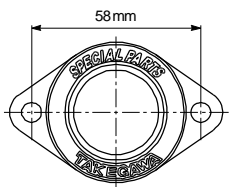

00-03-0210

for PE28

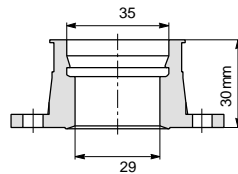
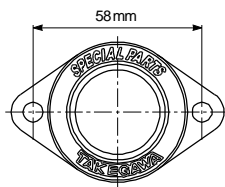

00-03-0211

## Involute throttle set



Outer length: 710 mm  
**09-02-0230** (Black anodized)  
**09-02-0232** (Gray metallic anodized)  
 Outer length: 810 mm  
**09-02-0231** (Black anodized)  
**09-02-0233** (Gray metallic anodized)

## Standard high throttle set



**09-02-0222** (710 mm in outer length)  
**09-02-0221** (810 mm in outer length)

## 90-bent high throttle set



**09-02-021** (700 mm in outer length)

For more information, please refer to our parts catalog, or log onto our Web site at URL <http://www.takegawa.co.jp>



## Racing C.D.I. Magnet Kit

05-02-0511



Excellent startup performance because of ignition at low revolution. (Excellent start-up by a kick starter)  
 Ignition timing adjustable at up to 24 degrees,  
 Integral ignition coil with built-in CDI unit,  
 Fully-covered stator coil to protect the ignition coil,  
 Weight saving:  
 R-type 58 rotor: 336 g  
 Stator, including cords: 383 g  
 Ignition coil, including cords: 370 g  
 "ROSSA" (red) as proof of high performance  
 No charging functions

### Kick starter arm

(Steel-forged)

(Aluminum-forged)

(For rubber hose)

### Oil cooler adaptor unit (Type-1)

(For Slim Line hose)

(For Alligri hose)



02-08-0043



09-10-006

(Back step should not be installed.)



09-07-056



09-07-0562



09-07-0561

### Steel Drive Sprocket



02-05-01 (12T Standard)  
 02-05-02 (13T Standard)  
 02-05-03 (14T Standard)



02-05-041 (15T Racing)  
 02-05-051 (16T Racing)

### Aluminum Driven Sprocket



02-07-0635 (35T)    02-07-1225 (25T)  
 02-07-0638 (38T)    02-07-1228 (28T)  
 02-07-0641 (41T)    02-07-1230 (30T)  
 02-07-0642 (42T)    02-07-1233 (33T)  
 02-07-0643 (43T)    02-07-1235 (35T)

### Steel Driven Sprocket



02-07-0007 (23T)  
 02-07-025 (25T)  
 02-07-028 (28T)  
 02-07-030 (23T)

### Gear Ratio (Final)

Drive \ Driven	23T	24T	25T	26T	27T	28T	29T	30T	31T	32T	33T	34T	35T	36T
12T	1.91	2.00	2.08	2.17	2.25	2.33	2.42	2.50	2.58	2.67	2.75	2.83	2.92	3.00
13T	1.76	1.84	1.92	2.00	2.08	2.15	2.23	2.31	2.38	2.46	2.54	2.62	2.69	2.77
14T	1.64	1.71	1.79	1.86	1.93	2.00	2.07	2.14	2.21	2.29	2.36	2.43	2.50	2.57
15T	1.53	1.60	1.67	1.73	1.80	1.87	1.93	2.00	2.07	2.13	2.20	2.27	2.33	2.40
16T	1.43	1.50	1.56	1.62	1.68	1.75	1.81	1.87	1.93	2.00	2.06	2.12	2.18	2.25

For more information, please refer to our parts catalog, or log onto our Web site at  
 URL <http://www.takegawa.co.jp>

## Oil cooler

### Super cool type A / AL (with internal threads)

Super Cool Type A is an oil cooler coming with internal threads for attaching an adaptor to the oil cooler. As far as our products are concerned, this internal thread is used in the Super Cool Kit with a rubber hose and a Slimline hose. With an extra-cost fitting adapter, the Allegri mesh hose can also be attached. However, please be advised that Allegri mesh hoses are designed for exclusive use, not for general use.



3-Fin 4-Line A  
00-07-0045

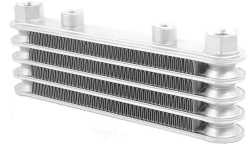

4-Fin 5-Line A  
00-07-0004

### Oil cooler plates for Oil Coolers A & B

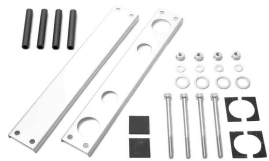

For Super Cool 4F6L (A) / 4F5L (B)

09-07-021 (blue)

09-07-022 (red)

09-07-023 (gold)

For Super Cool 3F4L (A) / 3F4L (B)

09-07-025 (blue)

09-07-026 (red)

### Oil cooler guard



09-07-006 (3F4L)

09-07-002 (4F5L)

### Compact cool

The oil "Compact Cool" is designed more compact compared to our current oil cooler and the best for mini motorcycles such as Monkey / Gorilla. The oil passage is our Standard Type and the corrugated louver fins are incorporated. This cooler body has an oil cooler plate and guard as standard equipments. In addition, the bracket mounting is integrated with the oil cooler plate so that you can use the oil outlet upside down as well.



3-Fin 4-Line AW  
00-07-0055

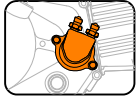

4-Fin 5-Line AW  
00-07-0008

Oil cooler		Super cool	
Mounting Position	Outlet	 Steering Stem mount	
		3Fin 4Line	4Fin 5Line
 Clutch cover	Rubber hose		
	Slimline hose	09-07-2611	09-07-2601
	Allegri braided oil line		

For more information, please refer to our parts catalog, or log onto our Web site at URL <http://www.takegawa.co.jp>

## Oil catch tank

(cylinder type)



**07-05-0010**

Tank capacity : 420 cc

(side cover type)



**09-04-032**

Tank capacity : 550 cc

## Front fork



**0 6 0 1 0 7 2 8**

30 Front Fork Set w/Disc brake

(For 10-inch ONLY)

Our original front fork with 30 inner tube increases the stability of stroke by damping force generating mechanism of "free-valve" type and reduces the shock when the front shocks rebound and compress.

## Rear fork



**0 6 0 3 0 1 0 4** Aluminum Swingarm (12cm-extended)

**0 6 0 3 0 1 0 5** Aluminum Swingarm (16cm-extended)

**0 6 0 3 0 1 0 7** Aluminum Swingarm(16cm-extended · With braced)

Both high rigidity and lightweight, which are both essential for swingarm, have been achieved with the well-balanced structure of our original polygon sectional design and thickness of the material.

Moreover, skillful bending and buff finish are excellent and appeal more than others.



**0 6 0 2 0 0 1 5**

Top Bridge & Stem



**0 6 0 1 0 7 2 3**

L / R Front Fork Set

## Tubeless wheel (10-inch)



**0 6 0 9 0 2 1 1** (3.5J)

**0 6 0 9 0 2 1 2** (2.5J)

**0 6 0 9 0 2 1 3** (2.75J)

For more information, please refer to our parts catalog, or log onto our Web site at  
**URL <http://www.takegawa.co.jp>**